

# **MONITORING COASTAL CHANGES ON TONGATAPU, KINGDOM OF TONGA**

Talanoafuka Kitekei'aho

SOPAC Secretariat

*December 1995*

*SOPAC Technical Report 218*

**This project was funded by the  
European Union (EU)**

## TABLE OF CONTENTS

	Page
EXECUTIVE SUMMARY.....	5
ACKNOWLEDGEMENT.....	7
INTRODUCTION.....	8
GENERAL.....	12
GEOLOGICAL SETTING OF THE BEACHES.....	12
PREVIOUS STUDIES.....	14
SAND EXTRACTION RATE.....	15
SOURCES OF SAND.....	16
RESULTS AND OBSERVATIONS.....	17
Data Points.....	19
Beach Profiles.....	19
Volume Calculations.....	20
Laulea Beach.....	22
Lavengatonga-'Oholei-Ha'asini Beach Tract.....	23
Fua'amotu.....	25
'Ahononou.....	26
Emelin.....	27
Felekie.....	28
Good Samaritan.....	29
Ha'atafu.....	30
Length of Beaches vs Volumes.....	31
DISCUSSION	
Sand Resources of Tongatapu.....	32
Effect of Beach Mining.....	34
Economic Value of Sand.....	35
Alternative Source of Sand.....	35
Beach Monitoring.....	36
CONCLUSIONS AND RECOMMENDATIONS.....	37
REFERENCES.....	39
APPENDIX	
A    Depths of Profiles	
B    Locations of Control Points	
C    Co-ordinates of the Control Points	
D    Volume Calculations	
E    Swell and Wind Sea Directions	
F    Data Points ..... Volume Calculations	
G    Representative Profiles of the Beaches	
H    Proposal to Cabinet for an ICM for Tonga	

## LIST OF FIGURES

Figure		
1	Location Map.....	8
2	Tongatapu showing the beaches surveyed	10
3	Tongatapu showing the direction of longshore currents as generated by the prevailing southeasterly winds.....	13
4	Beach-sand Extraction, 1987-1994, Tongatapu.....	16
5	The position of the data points on: <b>A.</b> Profile with a well established berm. <b>B.</b> Steeply-dipping profile without a distinct berm.....	20
6	Ahononou Beach, showing the method of volume calculations.....	21
7	Length of Beaches <b>and</b> Volume.....	31
8	Length of Beaches <b>versus</b> Volumes.....	33

## LIST OF TABLES

Table		
1	Beach-sand extraction rates, 1987 - 1994 for Tongatapu.....	15
2	Length of beaches and volumes.....	31
3	Effects of 3 scenarios on the lifetime of sand resource on Tongatapu.....	32

## LIST OF PLATES

Plate		
1	The Sokkia SET 2C in the field.....	10
2	Sand mining operation at 'Ahononou Beach.....	17
3	Laulea Beach showing the extent of beachrock exposed.....	22
4	Lavengatonga Beach showing extensive exposure of beachrock.....	24
5	Fua'amotu Beach not being commercially mined.....	25
6	Ahononou Beach. Mining is done to the beachrock level.....	26
7	Emetine Beach. Note the mining depression close to the vegetation.....	27
8	Felekie Beach. Mining has completely removed most of the sand.....	28
9	Good Samaritan Beach.....	29
10	Ha'atafu Beach. Most of the beachrock has now been covered with sand.....	30

## EXECUTIVE SUMMARY

A survey using a Sokkia Total Station (SET 2C) to resurvey and delineate the sand resource of eight beaches on Tongatapu indicated a total volume of about 395,000 tonnes. Using the annual extraction rate of 15 000 tonnes indicates a lifetime of 26 years for this resource. However, this figure is further revised assuming firstly, that Fua'amotu Beach would not be commercially mined, due to its proximity to the King's holiday home and, secondly, the southern portion of the Lavengatonga Beach tract would not be mined due to lack of proper roading. This is the worst-case scenario and the most conservative approach to take. This would significantly reduce the total sand volume by about 55%. The revised volume under this scenario therefore would be 169 450 tonnes. Using the current annual extraction rate of 15 000 tonnes, a lifetime of only 11 years is indicated for the sand resources on the beaches of Tongatapu.

The detrimental effect of beach mining has been noted from aerial photographs (1968, 1990) and other scientific studies that have been carried out in the area. At Laulea and Lavengatonga where most of the sand supply has been taken from over the years, both beaches record a landward migration of the coastline of about 50 m.

The rate of sand production has been estimated from the annual production rate of the reef to be about 7500 tonnes. The annual extraction rate, estimated at 15 000 tonnes, far exceeds the production rate of the reef. Another important contributor to beach materials is the foraminifera (forams). They lived on the reef flat and are roughly estimated to make up 40% of the sand on Tongatapu. Samples have been sent to New Zealand for analysis on the forams percentage composition and their life cycles. The results would assist in delineating the correct production rate of the reef and perhaps help in determining a sustainable level of mining.

Also of concern is the effect of cyclones on the coastline. The response of a mined beach would be a sudden readjustment of its profile and it usually takes much longer to recover itself. The recovery usually happens at the expense of other beaches and erosion of the higher and older pumice terrace. This flow-on effect of beach mining has been causing problems to adjacent properties of coastal landowners and resort owners. When this effect is considered with the imbalance in production versus extraction, beach mining cannot be sustained for long. There is a need to look at alternative sources other than beach mining.

An alternative source was delineated northwest of the island of Fafa by SOPAC in 1990 to have a volume of about six million tonnes. The mining of this deposit will allow the beaches to recover and assume its aesthetic value upon which tourism and the local economy can build. The economic value of the sand can be related to its opportunity cost. If it is instead developed in

terms of tourism, by promoting white sandy beaches, the 'real' economic value of sand can be in the millions of dollars annually.

In order to properly manage the coastline and its resources there needs to be clear guidelines to follow; an integrated approach by all sectors of the society. The management of the coastline should be placed under the jurisdiction of a single agency. Some guidelines have been forwarded to the Cabinet in Tonga for consideration under a paper titled "Integrated Coastal Management for Tonga" formulated by the Government heads, private sector organisations heads and NGO's, under the guidance of SOPAC and SPREP representatives. This was an integrated effort by all concerned with the coastline in Tonga. If Cabinet approves some of its recommendations, then this paper would provide the basic guidelines needed to manage this precious resource.

## **ACKNOWLEDGEMENTS**

The project was funded by the European Union (EU).

It was well supported by the Ministry of Lands, Surveys and Natural Resources through its head, Mr Sione Tongilava who is also national representative to SOPAC. I would like to also thank Uilou Samani, Tevita Fatai and Rennie Vaiomo'unga for the great assistance throughout the survey and the "Boys" from the sand depot at Vaololoa, for providing the strong arms for the iron rod.

For their helpful comments on the report Graham Shorten, Don Forbes and Russell Howorth are also acknowledged.

## INTRODUCTION

### Background

This study was aimed at providing information on the coastal changes on Tongatapu in the Kingdom of Tonga (Figure 1), as a response to a request from the Government of Tonga through its Ministry of Lands, Surveys and Natural Resources. This study was allocated the SOPAC Program number TG.13/9502 and was conducted during the period 29 August to 15 September 1995.

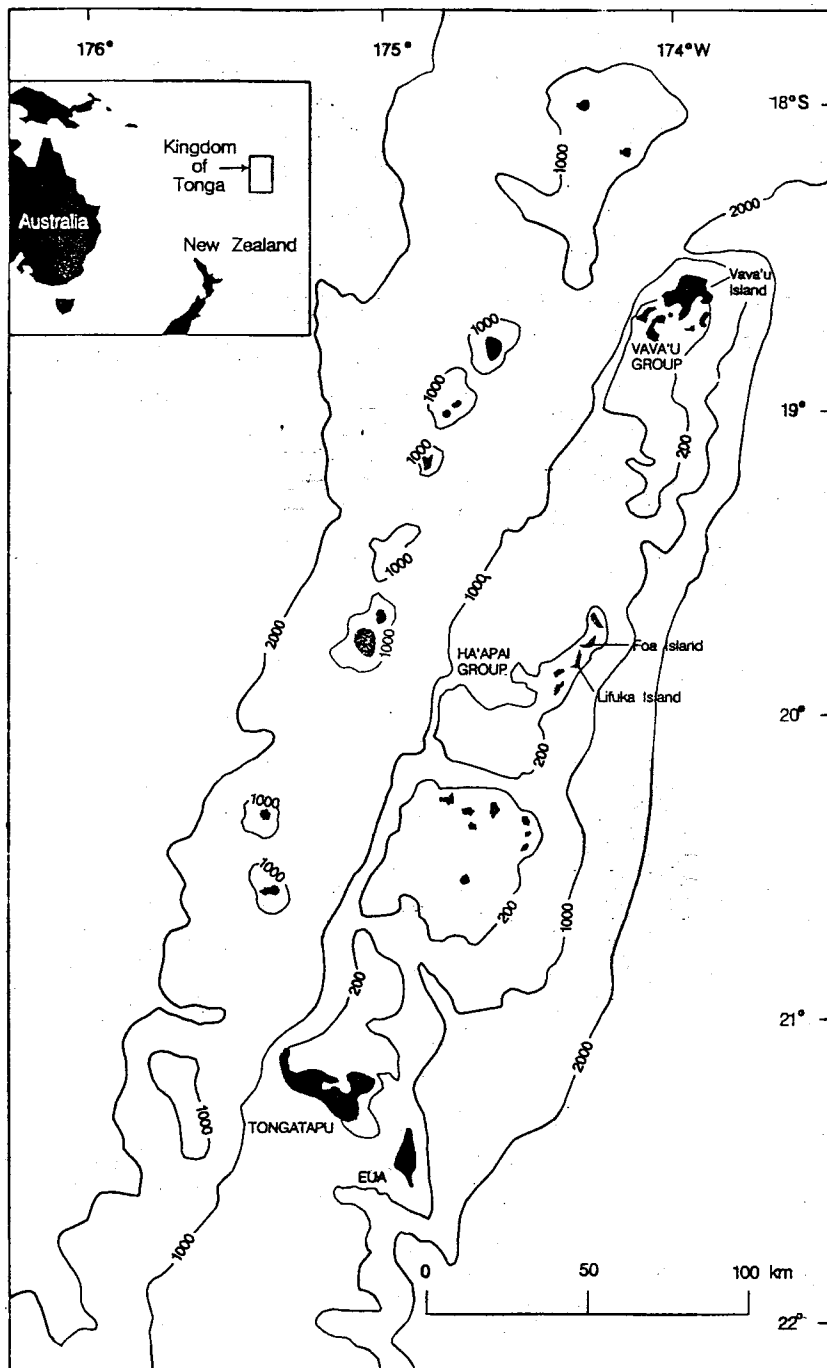

Figure 1. Location map.

The study was planned to have been carried out in conjunction with Program TG.13/9501 which was an aerial photo survey of critical sites along the coast of Tongatapu. Delay in getting approval required on the frame for the camera plus the unfavourable cloud conditions at that time, ruled this part of the survey out.

## **Objectives**

The objectives of this study were as follows:

1. Resurvey and delineation of the sand resource of eight beaches on Tongatapu
2. Evaluation of the extent of recent coastal changes on Tongatapu including changes effected by cyclones and other natural events, beach sand extraction, and interaction between the two.
3. Investigation of the rate of sand production and implications for the sustainability of beach mining.
4. Evaluation of the procedures for coastal monitoring and resource management on Tongatapu and recommendations for a viable monitoring program in support of the Integrated Coastal Area Management initiative.

A more detailed comparison of the results of this study with previous work by Tappin (1993) on some of these beaches will be dealt with in a later paper.

## **Method of Study**

The study involved resurveying beach profiles on the main beaches of Tongatapu and some pocket beaches which are either being currently mined or about to be mined. These are Laulea, Lavengatonga-'Oholei-Ha'asini beach tract, Fua'amotu, 'Ahononou, Ha'atafu, Good Samaritan, Emeline and Felekie (Figure 2).

The resurveying of the beaches was carried out using SOPAC's newly acquired Sokkia Total Station Set 2CII (Plate 1). The Sokkia Total Station Set 2CII is an advanced surveying instrument equipped with the following main features:



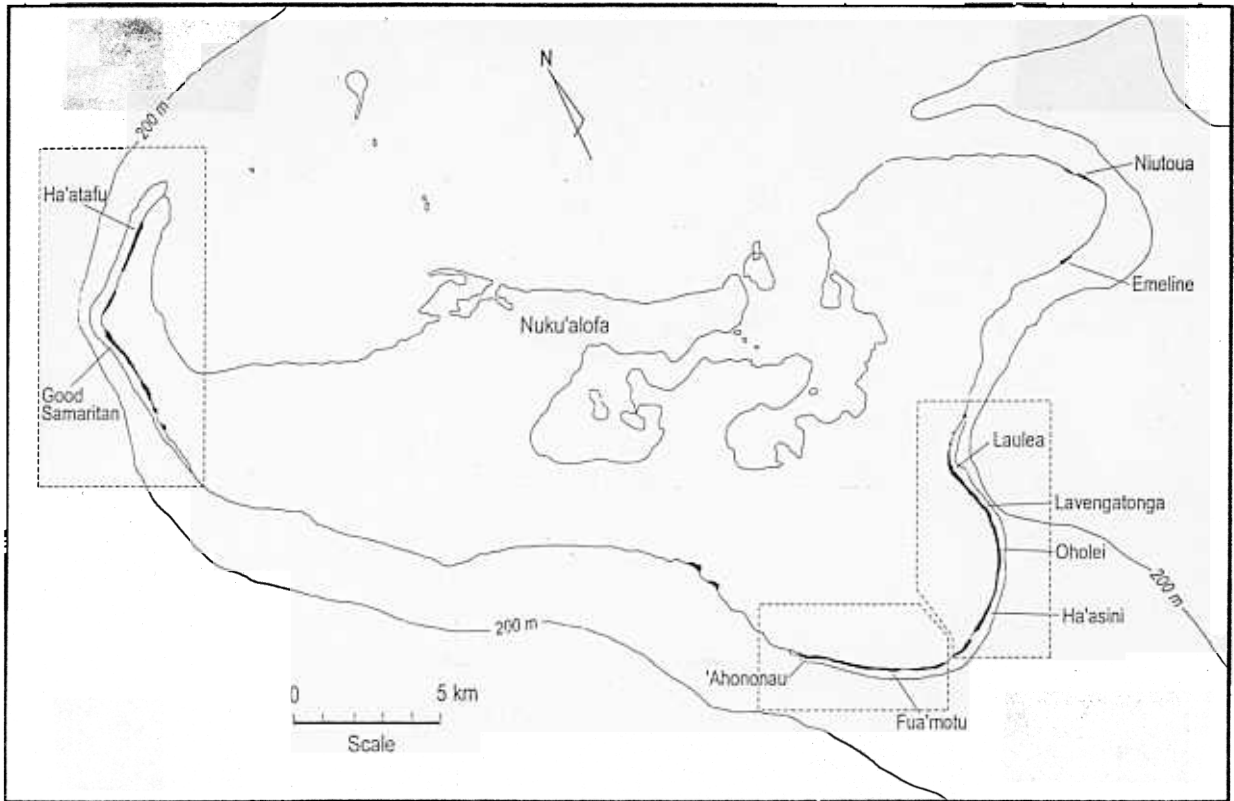

Figure 2. Tongatapu showing the beaches surveyed.



Plate 1. The Sokkia SET 2C in the field.

- . Advanced measurement features (Resection measurement, Traverse style coordinate measurement, offset measurement, REM measurement, missing line measurement, setting out measurement)
- . Memory card operation
- . Tilt Angle compensation
- . Collimation program
- . Data output.

The method provides a new survey technique which is faster than the normal levelling technique and stands out with its capability to download data straight to a computer. The data can then be manipulated to fit the clients' requirements. Although the capability of the equipment has wider applications, its use in coastal change surveys provides quick information to assist in making informed coastal management decisions.

The depths of profiles were determined by sounding with a 3 m steel rod. These data are presented in Appendix A. Not every profile was sounded for depth, in the case of the longer beaches every alternate profile was sounded and in the small pocket beaches, almost every profile was sounded.

An attempt was made to utilise all the control points set up by Tappin (1993). A team of surveyors from the Ministry of Lands and Surveys, and Natural Resources was mobilised to determine the coordinates and height of these control points in order to tie this work to the national grid.

The horizontal angles were determined from either setting zero on a known point (two control points were established on most beaches) or where only one control point exists, zero was taken on Magnetic North, using the magnetic compass provided with the Set 2C. This was the case for Fua'amotu and 'Ahononou beaches.

Sketches to show the locations of the control points for the beaches surveyed are shown in Appendix 6. The coordinates of the control points are given in Appendix C.

The profiles were drawn using the software Microsoft Excel 5.0. The data points plotting and volume calculations were carried out using Surfer 5. The volume calculations were carried out using a density of 1.5t/m. This was derived from the bulk density determined by Tappin (1993) for carbonate material in Tonga to be 2.05t/m reduced by 30% which is a typical porosity for coral sand.

Aerial photographs from 1968 and 1990 were used in studying coastal changes. Sampling for foraminifera studies were also carried out on all the eight beaches.

## GENERAL

Tongatapu is the largest island of the Kingdom of Tonga (Figure 1). The capital of Nuku'alofa is situated there and more than half of the Kingdom's population of about 90 000 live on this island. Tongatapu has an area of about 260 km and the large population that it supports (about 65 000), exerts a lot of pressure on the land. The development of the island requires a large supply of sand.

Sand, as fine aggregate for construction purposes, on the island of Tongatapu is derived mainly from mining of the beaches. This is supplemented by a small amount of fines from the quarries. The beaches being mined so far are found on the western part, southeastern corner and the eastern part of Tongatapu (Figure 2).

The mining of the beaches has led to complaints being made by different sectors of the community but especially the coastal landowners and resort owners. Their concerns were based mainly on the landward migration of the coastline and the apparent loss of sand in resort areas which are not directly being mined. The process of longshore drift is continuous and occurs to keep the beach in a dynamic equilibrium. It is more apparent during stormy conditions.

Figure 3 shows the direction of longshore drift that would be generated by a prevailing southeasterly wind and southerlies swell. Commercial beach mining can cause a state of disequilibrium by creating a large hole on the beach which will cause nature to readjust by shifting sand from unmined beaches to fill the hole created. The direction of sand movement along the southern coastline is depicted by the arrows on Figure 3. This movement will occur until a state of equilibrium is reached. Continued mining of beaches means the continued readjustment of beaches by the process of longshore drift which is the case in Tongatapu. Other natural processes such as the readjustment of the beach profile after a storm by the reworking of existing fossil sand and the final positioning of the storm level higher up inland also occurred. This may result in the widening of the beach but the overall depth of sand has been reduced. This process can fool decision-makers at times when the beach being mined appears to be replenished instantly during and after stormy weather. One only has to look further along the coastline to realise that this "instant" replenishment is at the expense of adjacent unmined beaches.

## GEOLOGICAL SETTING OF THE BEACHES

The Kingdom of Tonga is formed as a double chain of islands (Figure 1). The islands of the western chain are volcanic, delineated by the Tofua Arc, while the islands of the eastern chain are

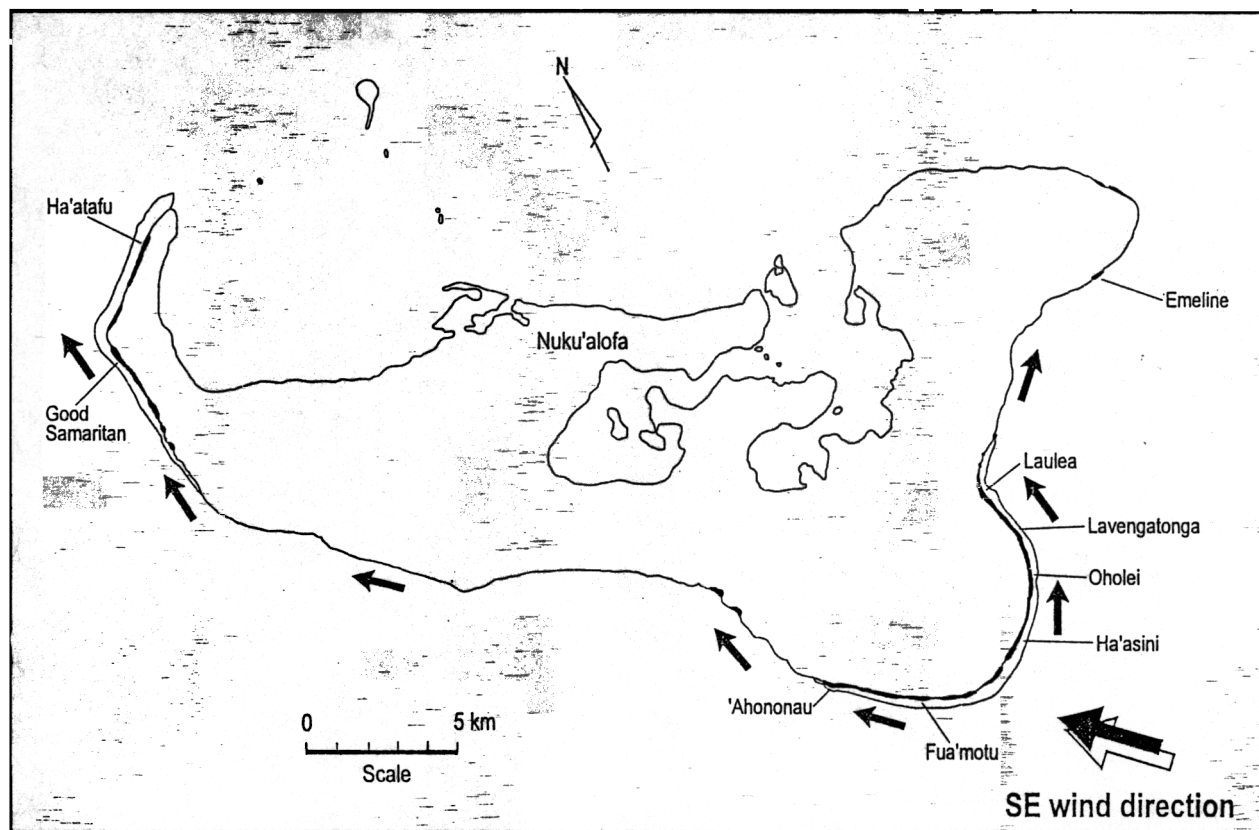

Figure 3. Tongatapu, showing the direction of longshore currents as generated by the prevailing southeasterly winds

mostly of raised reef limestone. The Kingdom of Tonga is situated close to the eastern boundary of the Australian Plate and has been classed as a classic simple island arc (Packham, 1978). Subduction of the Pacific Plate underneath the Australian Plate occurs immediately to the east of the Kingdom of Tonga. Tongatapu is the largest of the three main islands of the Kingdom. It belongs to the eastern chain of islands which is composed mostly of Pliocene to Holocene limestones which overlie older volcanic rocks (Cunningham and Anscombe, 1985).

The coastline of Tongatapu can be described in two portions, the southern and the northern coastlines. The southern coastline is defined to extend from north of Emeline Beach on the east coast along to Ha'atafu Beach on the west (Figure 2). It is characterised by a high-standing algal reef on the ocean side and bordered on the landward side by uplifted reef terraces. The fringing reef width varies from 25 to 200 m and comprises a reef face, algal terrace and reef flat. The fringing reef appears to widen towards the western part of Tongatapu. The height of the algal terrace was also recognised to decrease towards the west. On the landward side, the uplifted reef terraces are more pronounced on the east and gradually become less visible along the coastline

towards the west. In contrast, the northern coastline, including the coastline around Nuku'alofa, is low-lying and mangrove-fringed with narrow beaches. The fringing reef is much wider and mostly submerged during high tide. The uplifted reef terraces are absent along this part of the coastline.

The geomorphology of the Tongatapu coastline as described above suggests a combined northward and westward tilt of Tongatapu, with the northward tilt representing the major component.

The beaches studied during this survey are along the southern coastline. The dominant wind direction is southeasterly making the southern coastline a high energy environment. Unlike the winds, the waves on the south coast of Tongatapu are seasonal, reaching a maximum between May and July of about 2 m and decreasing to 1.5 m during the summer months. The swell at times is generated up to 5 m in height and directed mostly from the south. Recordings were made in 1991 by a waverider buoy, under a SOPAC/OCEANOR/NHL Wave Energy Program (Barstow and Haug, 1994). Appendix E shows the rose diagrams on the swell and wind sea directions on the south coast of Tongatapu.

## **PREVIOUS STUDIES**

SOPAC studies first began in early 1970's with a beach monitoring program. The search for an alternative source of sand first began in 1982 with work by Tiffin (1982) on an onshore inland area near Kolovai in the western peninsula of Tongatapu. This deposit was found to be too fine to supplement the sand requirement for construction purposes.

Initial offshore work looked at several areas. The deposit near Fafa became the focus of follow-up work. The search for offshore sand deposits was initiated in the 1980's with a shallow seismic survey (Richmond, 1987). The initial estimate and interpretation of this seismic survey (Harper and Kitekei'aho, 1988) was followed by a vibracoring survey which estimated a reserve of about 4 000 000 m<sup>3</sup> or 6 000 000 tonnes, at an average water depth of about 14 m (Smith and Gatliff, 1991). This was followed by a study on the area (Kitekei'aho and Yeo, 1993), directed at determining the current directions at both high and low tide periods. This was necessary to predict the directions of movement of a sediment plume that may be generated during mining of such a deposit.

The study by Kitekei'aho and Yeo (1993) on the sand deposit offshore Fafa showed a circulation pattern that posed little pollution problem to nearby islands and the northern coastline of

Tongatapu. Furthermore, the finest sediment in the area may not be as light as the dye used on the experiment, to be suspended causing a sediment plume. The mining of this deposit still awaits an environmental impact study on the biological assemblages in the area. The next logical step after this will be to either prepare tender document, or if Government is interested in the operation, to seek bilateral assistance for the development. The Fafa offshore sands represent an alternative source of sand to beach mining. Using an average consumption rate of 15 000 tonnes on the calculated reserve of 6 000 000 tonnes, the Fafa reserve represents 400 years supply of sand.

Tappin (1993) conducted the first study into determining the total available sand on Tongatapu, Ha'apai and Vava'u, using similar equipment to that used during this survey. On Tongatapu he estimated the sand supply from 13 beaches he surveyed, to have a lifetime of 28 years, using an extraction rate of 14,000 tonnes.

Meanwhile the mining of beaches still continues. The beaches being mined at the time of this study were: 'Ahononou, Felekie and 'Emeline. The damage on these beaches is quite severe and will be discussed later.

### SAND EXTRACTION RATE

The production statistics for Tongatapu showed an average annual extraction rate of sand from the beaches on Tongatapu to be about 15 000 tonnes based on data from 1985 to 1994 (Table 1 & Figure 4).

*Table 1. Beach-sand Mining rates, 1987-1994, Tongatapu.*

Year	1987-88	1988-89	1989-90	1990-91	1991-92	1992-93	1993-94
Extraction	13445	14200	14135	14135	11310	15000	12800

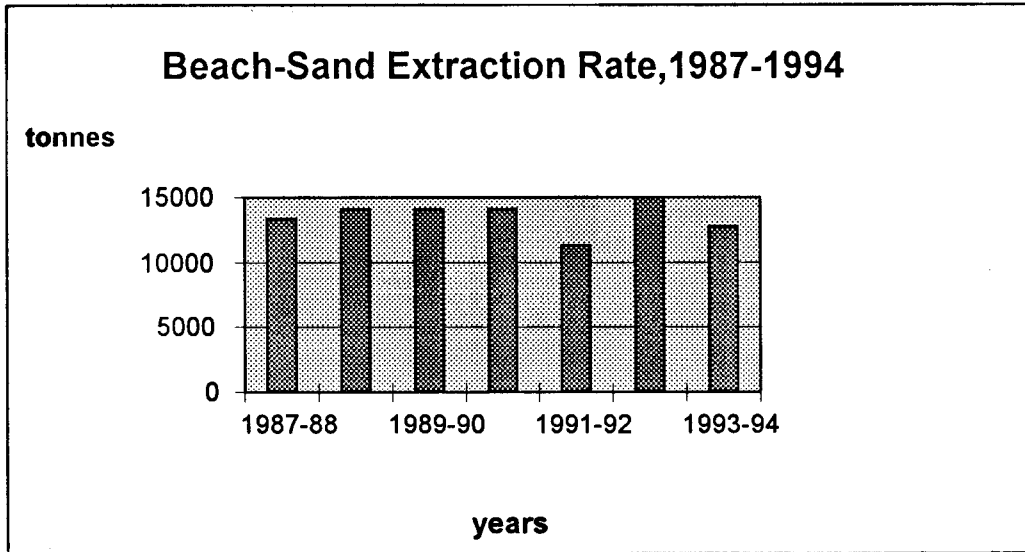

*Figure 4. Beach-sand extraction rates, 1987-1994, Tongatapu.*

The sand is being mined using a front end loader which scoops and loads sand onto trucks (Plate 2). The operation is sponsored by Government under contract to private trucks and owners of front end loaders. The sand is being transported to local stockpile depots around Tongatapu where it is sold to the public. The main stockpile is situated at Vaololoa, near Nuku'alofa to serve the purpose of housing and road construction around the main town. The sand is currently sold at \$12.00 per tonne by Government.

The bulk of the sand used to be extracted out of Laulea and Lavengatonga beaches, mainly because of their size, and accessibility by road. Tappin (1993) estimated 136 000 tonnes as the combined volume for these two beaches. These two beaches therefore represent only 9 years life supply on the current consumption rate. Currently sand requirements are being extracted from the western end of 'Ahononou Beach (Figure 2) which is also accessible by road. However this portion of the beach was very close to being exhausted at the time of this survey (refer to Appendix A for the depth of the profiles on this beach). Plans are underway to shift beach mining to Emeline and Felekie beaches when the western portion of 'Ahononou Beach runs out.

### SOURCES OF SAND

Sand is provided and transported to the beaches by means of wave action on the fringing reef which surrounds the island. The prevailing southeasterly wind and the southerly swell are responsible for most of this action.



*Plate 2. Sand mining operation at 'Ahononou Beach.*

The other contributing elements to the sand on the beaches are foraminifera. They are tiny organisms that lived on the reef flat among seaweed. When they die they are transported to the beach and can be distinguished by their variety of colours and shape. They are roughly estimated to make up about 40% of the sand on most beaches on Tongatapu. The ratio of coral to forams will be confirmed when samples collected from most of the beaches have been analysed by Professor John D. Collen of Victoria University of Wellington. An important part of this analysis is to look at the life cycle of the forams which will be useful in determining the rate of supply to the beach and may have some bearing on a sustainable extraction rate of sand from the beaches.

## **RESULTS AND OBSERVATIONS**

The following eight beaches (Figure 2) were selected for this survey (the number of days spent on each beach is shown in parentheses):

1. Laulea (3 days)
2. Lavengatonga - 'Oholei-Ha'asini beach tract (3 days)
3. 'Ahononou (1 day)



4.	Fua'amotu	(2 days)
5.	Good Samaritan	(1 day)
6.	Ha'atafu	(2 days)
7.	Felekie(Niutoua)	(1 day)
8.	'Emeline	(1 day)

Identification of control points for both beach profiling and aerial photography took three days. The rest of the time was spent on arranging for the aerial photography, which was eventually postponed (SOPAC Trip Report 211).

The following criteria were important in the selection of each site to be surveyed:

- whether it had been mined in the past;
- if not, its proximity to the mined beaches;
- its suitability as a future mining location.

Beaches with known mining history are Laulea, Lavengatonga, Ha'atafu, Good Samaritan and 'Ahononou. 'Emeline and Felekie were supposedly earmarked for future mining looked as though they were being mined extensively at the time of the survey. Fua'amotu Beach has no history of commercial mining, although small-scale extraction for funerals has occurred. Since this beach is close to the King's holiday home it is highly unlikely to be mined commercially in the future. The Lavengatonga-'Oholei-Ha'asini beach tract on the eastern coastline could provide good data for determining the effect of longshore currents on beach development and recovery from mining impacts. The same applies to the Good Samaritan and Ha'atafu beaches.

The following visual observations were made on the beaches surveyed:

- there is extensive exposure of beachrock (Plates 3, 4 and 8);
- a landward retreat of up to 50 m has been recorded on some beaches since 1970's;
- some beaches that are not being mined show signs of losing sand.

Of all the beaches being mined Laulea, Lavengatonga and Good Samaritan, appear to have suffered the most damage (Plates 3, 4 & 8). Ha'atafu Beach appeared to have recovered quite well since the last recorded commercial mining almost 15 years ago.

According to local information, storms appear to be the most common cause of radical changes on the coastline. Beaches which are being mined experience landward migration of the coastline and reworking of the backshore pumice terrace (Tappin, 1993). The effect on the adjacent beaches is that also of erosion, as sand is being shifted in the direction of longshore current

towards beaches which are being commercially mined. This case is true of the Laulea and Lavengatonga-'Oholei-Ha'asini beach tract and the Good Samaritan and Ha'atafu beaches (Figure 3). The ultimate sinks for sand transported along the coastline, as a result of this longshore current, are Laulea for the eastern coastline, Ahononou for the southern coastline and Ha'atafu for the western beaches.

### **Data Points**

The landward boundary for the data points was the storm level and the end of the sand for the seaward side. In case of heavily vegetated beaches (eg. southern end of Lavengatonga-Oholei-Ha'asini beach tract), the landward boundary was the seaward edge of the vegetation. The edge of cliff terraces were also used as a landward boundary whenever they existed. The data points plot for most of the beaches are shown in Appendix F. The diagrams were drawn using Surfer 5. Some problems were encountered with some of the data points on Laulea Beach. The reason is unknown at the moment but the data can be verified on a future survey. This problem resulted in there being no data points diagram included in this report for Laulea Beach. The profiles for Laulea Beach were unaffected and are presented here like the rest of the other beach profiles, using Excel 5.0 (Appendix G.1).

### **Beach Profile6**

A total of about 158 profiles were taken on the eight beaches surveyed. Representative profiles to show major changes on each beach are shown in Appendix G. Sketches of typical profiles are shown below to show how the data points were collected (Figures 5a and 5b). The berm was found to be better defined defined on the profiles in the middle part of Laulea and the northern portion of Lavengatonga beaches. This was also true of Ha'atafu Beach. Such a form has been described to represent an established and mature state of the beach (Lewis *et al.* 1991).

Only the profiles that were sounded for their depths are presented to be representative of each beach. The distance between profiles ranged from 50 m to 100 m for longer beaches and less than 25 m for shorter beaches. Refer to data point plot for locations of the profiles (Appendix F). The depth points were collected almost exactly where the data points for the profiles were collected.

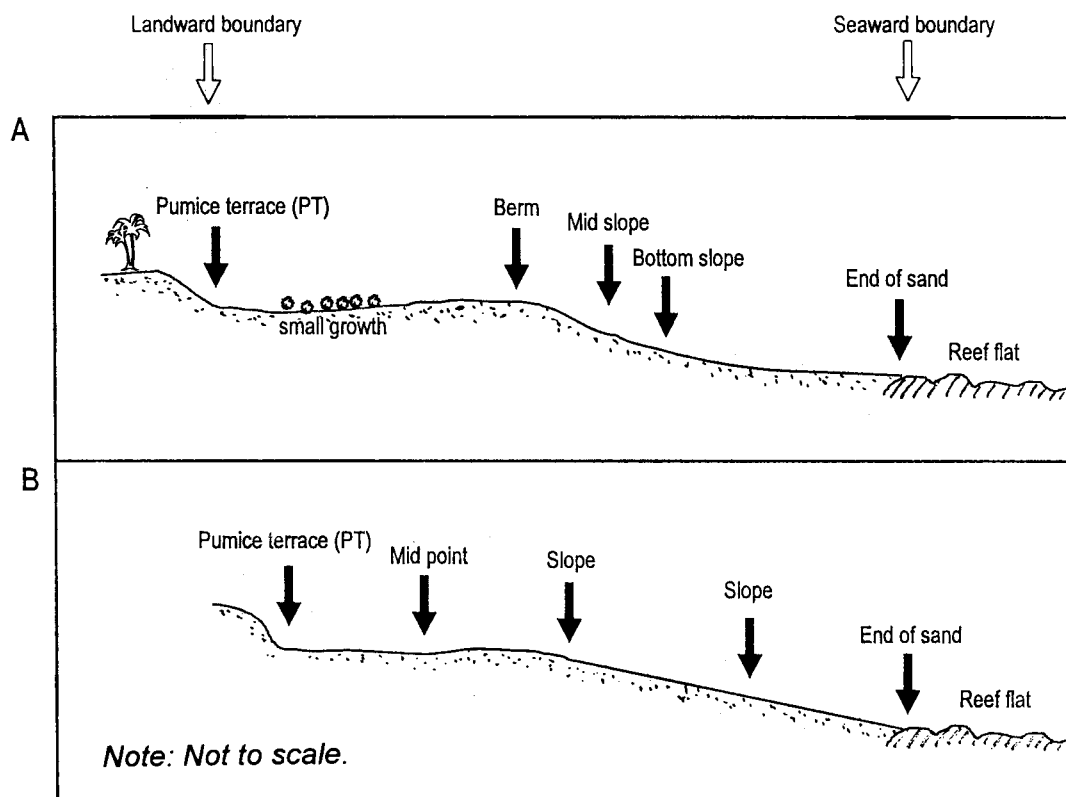

Figure 5. The position of the data points on: **A.** Profile with a well established berm. Arrows indicate areas where data points were taken. **B.** Steeply-dipping profile without a distinct berm. Arrows indicate areas where data points were taken.

The following is a description of the surveyed beaches in terms of their physical states based on photos and cross section profiles. A summary of the length of the beaches versus volumes is presented in Table 2 and Figure 7 at the end of this section.

### Volume Calculations

The volume calculations were done using *Surfer 5*. The program uses the maximum and minimum coordinates of the data points to delimit a rectangle. The heights of the data points are then contoured for the whole rectangle (Figure 6a). The actual volume of the sand is calculated however by blanking the area of the rectangle outside of the beach area (Figure 6b). The volume is then calculated using the two surfaces (i) the beach and (ii) the underlying rock. An example is given in Figure 6.

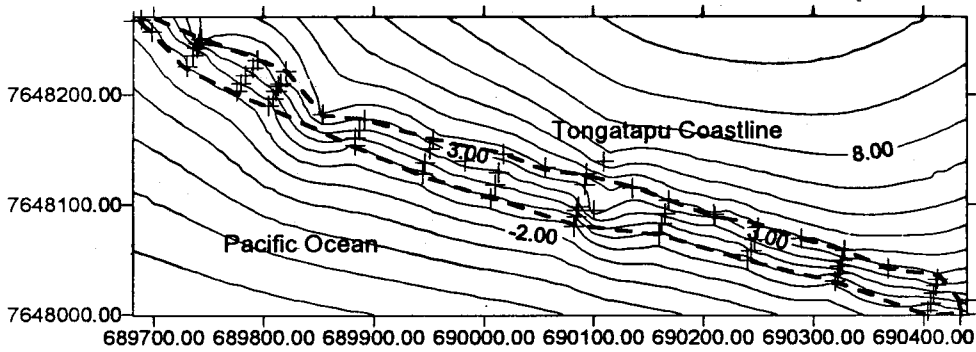

Fig 6a. Contour of the beach surface showing the positions of the data points. Dashed line shows the upper boundary (Pumice Terrace/ cliff) and the lower boundary (end of sand).

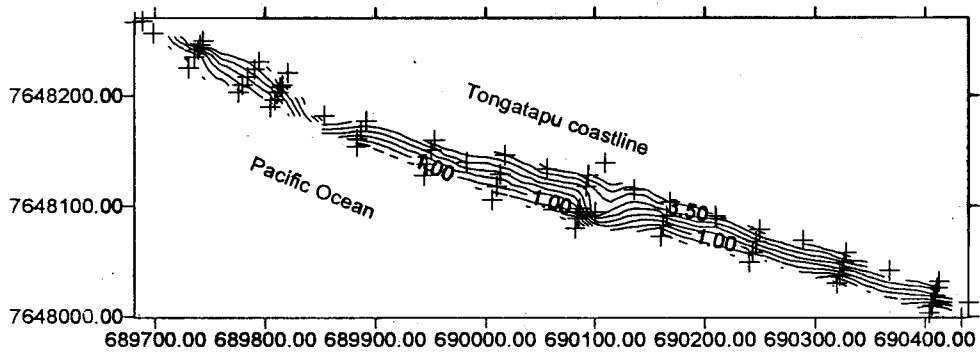

Fig. 6b. Contour of the blanked surface topography of the beach. This is the portion used for the volume calculations.

Figure 6. 'Ahononou Beach, showing the method of volume calculations.

The volumes are reported in cubic metres ( $m^3$ ), using 3 different methods (Appendix D). They are the *Trapezoidal Rule*, *Simpson's Rule* and *Simpson's 3/8 Rule*. The closer are the three results the closer the true volume.

The volume is reported as the average of the 3 methods mentioned above in cubic metres which is converted to tonnes using a density of  $1.5t/m^3$ . The figures are reported in Table 2.

The volume of sand for Laulea Beach was however calculated using *Excel 5.0*, to calculate the sectional area of the profiles. The volume between two profiles is equal to the average sectional area multiplied by the distance between them.

## LAULEA BEACH



*Plate 3. Laulea Beach showing the extent of beachrock exposed by beach mining.*

Laulea Beach is located on the eastern part of the southern coastline, marking the northern end of a chain of long beaches which started from Ha'asini on the south (Figure 2). It is separated from the long beach tract of Lavengatonga-'Oholei-Ha'asini by small pocket beaches and cliffs. The beach is about 1.1 km long and faces the dominant southeasterly trade winds. A total of 19 profiles were taken on this beach at an average spacing of 50-100 m. The beach is easily accessible by road and very popular as a picnic venue.

The longest profile, about 50 m, was found in the middle portion of the beach. The long profiles at this portion are flanked either sides by shorter profiles of about 10 to 15 m long at either end of the beach. The thickness of the sand tends to increase to the south although the profiles are shorter (see Appendix G.1). The original beach profile would have been much wider to the north as evident from the much wider area covered by beachrock on this part of the beach (Plate 3). Beachrock is quite extensive on the toe of the beach for most its length. This is absent from the 1968 aerial photos. The aerial photos showed an extensive beach which was up to 100 m in some places from the pumice terrace. The 1990 aerial photos showed a narrower beach in the expanse of extensive beachrock. The commercial mining of Laulea Beach was at its peak during

this period and therefore partly responsible for this coastal change. A total of about 50 m landward migration of the storm level has been estimated for this beach, due to a combination of beach mining and storms (Gauss and Carter 1982, Tappin 1993) .

The average sand thickness is less than a metre with no particular profile depth reaching two metres (Appendices A.1 and G). The beach has an average width of 24 m from storm level to the end of the sand at the toe of the beach. The volume of sand has been calculated to be about 12 000 m (18 000 tonnes).

No 1968 aerial photographs of Laulea Beach were available but the area of beachrock showed by the 1990 aerial photos does not match the larger area covered by beachrock, observed on this survey (Plate 3). The sand appeared to have either been mined out or moved out towards the re-entrant on the reef, facing the road into Laulea Beach.

The beach has a long history of mining which began in the 1970's. It was recorded that the mining of the beach in late 1979 to early 1980 coincided with the March hurricane of 1980 which resulted in the destruction of the berm and back beach area. A retreat of about 50 m in some parts of the beach (Gauss and Carter, 1982) was attributed to this effect. An almost complete recovery of the beach morphology followed after this but this was due to the reworking of the back beach berm and dune behind the storm level which resulted in the relocation of the storm level landward from its original position. However, further mining after this period resulted in further readjustment of the beach profiles landward as a response to Cyclone Kina, January 1993. Mining was carried out on the pumice terrace on this beach and evidence of this can be seen in the big holes left behind today at the pumice terrace level (Appendix G.1, Profile 13).

#### LAVENGATONGA-'OHOLEI-HA'ASINI BEACH TRACT

This beach tract represents the longest stretch, slightly over 4 m, of wide sandy beaches on the island of Tongatapu (Appendix F.1).

This beach tract is south of Laulea Beach (Figure 2) and accessible by road. The rest of the beach tract is south of Lavengatonga proper. The other part of the beach tract 'Oholei and Ha'asini are not easily accessible by road, for commercial mining to operate on them. One reason for this is the high uplifted reef terrace (about 4-5 m) which marks the landward boundary of the beach at this area. The whole length of the beach is, however, very popular for picnics.



*Plate 4. Lavengatonga Beach showing extensive exposure of beachrock due to mining.*

This beach has a similar mining history to Laulea Beach. Together these beaches have been the dominant suppliers of sand for the past 20 years. Extensive occurrence of exposed beachrock on both beaches, provide the evidence of excessive mining.

The beach reaches its maximum width, 30 m just north of 'Oholei Beach. The beach berm is well established around this area although visual inspection suggested this was due to a reworking of the back beach area. The original length of the profiles, as evidenced by the extensive area covered by beachrock (Plate 4) appeared to be much longer. This is also supported by the aerial photograph of 1968 which indicated an average width of about 60 m. In the area near the road into Lavengatonga a width of close to 100 m is suggested by the same photograph. The profiles of this survey however showed the actual area covered by sand to have an average width of only about 18 m. This indicated a landward shift of about more than 50 m. 1990 and 1968 aerial photographs both show a constant width for the length of the beach tract but increasing towards Lavengatonga proper and Laulea Beach. This is understandable due to the effect of longshore drift which constantly shifts sand northward in this area.

The total length of this beach tract is about 4.4 km. A volume of 78 000 m<sup>3</sup> (117 000 tonnes) was calculated for this beach. More than 90% of this total was mapped to the south towards the Ha'asini end. Most of this portion is not accessible by road for any commercial mining to operate.

### *FUA'AMOTU*

Easily accessible by tar seal road, Fua'amotu Beach remains relatively untouched compared with other long beaches on Tongatapu. It is about 2.5 km long and has an average width of 26 m. Most beaches of this size in Tonga would have been commercially mined already. This beach however has no recorded commercial mining activity over the years. The beach has little beachrock exposed and has a steep beach face perhaps recording the profile of an untouched beach (Plate 5). The reason this beach remains pristine is its proximity to the King's holiday home at Fua'amotu. The longest profile is more than 30 m with the average profile length about 26 m (Appendix G.3). The average thickness is about 0.75 m and the volume was calculated to be about 76 000 m<sup>3</sup> (114 000 tonnes).



*Plate 5. Fua'amotu Beach not being commercially mined. Note the sand spilling onto the reef flat.*



*'AHONONOU*

'Ahononou is situated on the south coastline marking the end of a chain of long beaches which started from Laulea on the eastern coastline (Plate 6). There are small pocket beaches west of 'Ahononou but are too small and inaccessible to be considered for commercial beach mining.

'Ahononou is considered to be the main sink for sand transportation on the southern coastline (Figure 3). It is 800 m long with an average width of about 30 m (Appendix F.3, Appendix G.4). The beach has a long history of mining. In 1991 mining was recorded to have stripped sand down to the beachrock in the area adjacent to the road (Lewis et al 1991). Mining today is being carried out on the western end of the beach and it is also done to the beachrock level (Plate 6).



*Plate 6. 'Ahononou Beach. Mining is done to the beachrock level at the western end of the beach.*

The longest profile on 'Ahononou is about 48 m from the storm level. The average thickness of sand is about 1 m. The volume of sand has been calculated to be about 27 000 m<sup>3</sup> (40 500

tonnes). Most of the beachrock exposed in 1991 has now been covered, except the lower part of the beach and the area that is currently being mined. This represents a remarkable recovery when compared with Tappin's estimation of the sand volume to be about 27 129 tonnes (Tappin 1993). The 1968 airphotos showed 'Ahononou to have a width of about 50 m. This fast recovery can be attributed partly to sediment transported by the longshore current that acts towards 'Ahononou Beach and the contribution from the erosion of the backbeach areas during Cyclone Kina, January 1993. Fua'amotu Beach which lies immediately to the east of 'Ahononou (Figure 3), could be contributing significantly to this recovery.

### *EMELINE*



*Plate 7. Emeline Beach. Note the mining depression close to the vegetation.*

Emeline is one of the pocket beaches north of Laulea Beach and situated near the village of Niutoua. It is easily accessible by road from the village of Niutoua and although unusually located it is now being mined commercially. According to sources from the Natural Resources section of

the Ministry of Lands, Surveys and Natural Resources, the reason for mining pocket and isolated beaches is because they are considered environmentally safer in terms of landward erosion.

The beach is 400 m long (Appendix F.4) with an average width of about 17 m from the storm level. The profiles show a thin layer of sand with an average thickness of 0.8 m (Appendix G.5) . The volume of sand was calculated at about 6000 m<sup>3</sup> (9000 tonnes).

### *FELEKIE*



*Plate 8. Felekie Beach. Mining has completely removed most of the sand from this pocket beach.*

As in the case of Emeline Beach, Felekie is another pocket beach which is now exposed to commercial mining. It is accessible by road and close to the village of Niutoua.

The beach has a length of about 150 m and an average width of about 8 m. The beach was found to be mined already when visited. The volume was calculated to be about 300 m<sup>3</sup> (450 tonnes). It was different from the other beaches in that it was completely surrounded by about 3 m of raised coral terrace. The fringing reef is only about 30 m wide at this part of the island also. There is no pumice terrace to be reworked during storms and because of its nature as a pocket beach, recovery could be very slow. The landward migration suffered by beaches like Laulea and

Lavengatonga may not be a problem here due to the natural protection provided by the elevated reef terrace however, it is still a fact that its aesthetic value as a picnic spot has been reduced drastically. The mining has totally destroyed this beach (Plate 8) and basically there is nothing left to be mined. The discolouration on the cliff edge marked the older beach level which is approximated to have reached 2 m depth near the cliff edge.

### *GOOD SAMARITAN*



*Plate 9. Good Samaritan Beach. The Good Samaritan Resort is at the northern end of the beach. Note the extensive exposure of beachrock*

This beach is situated south of Ha'atafu Beach (Figure 2). Situated on the northern end of this beach is the popular resort, the Good Samaritan. It is easily accessible by road from the village of Kolovai. Like Ha'atafu Beach, it was once regularly mined. Mining here has resulted in extensive exposure of beachrock on the lower half of the beach (Plate 9). The 1968 aerial photograph showed little beachrock exposed while this is more recognisable on the 1990 aerial photographs. The aerial photograph of 1968 indicates the width of the beach to be about 50 m. The recovery is very slow and most of the beach is still exposed today. This is probably due to the longshore

transportation of sand which acts to stabilise Ha'atafu Beach to the north, before any accumulation can start at the Good Samaritan. This beach used to be a popular picnic resort during 1970's and the width of the beach was much greater then.

The beach has a total length of about 650 m (Appendix F.5.) with the volume being calculated at about 4000 m<sup>3</sup> (6000 tonnes). The profiles have an average length of 25 m (Appendix G.6) with an average thickness of sand less than a metre.

### HA'ATAFU



*Plate 10. Ha'atafu Beach. Most of the beachrock has now been covered with sand.*

Situated along the western coastline (Figure 2), this beach is easily accessible by road from the village of Ha'atafu. A popular resort for surfing is situated on the widest part of the beach, at the northern end. This beach marked the end of long beaches that start at the Good Samaritan on the south. It is the sink for sand transportation along this part of the coastline.

It was once regularly mined although there has been no commercial mining recorded for the last 15 years. Considering a similar mining operation that would have exposed extensive beachrock, like Laulea, Lavengatonga and 'Ahononou, the beach is showing good recovery with very little

beachrock being exposed now. The beach has a length of 1500 m. The profiles have an average length of about 30 m with the longest profile length at about 45 m on the northern end of the beach. Most of the profiles at this part of the beach (Appendix G.8, Profiles 1 to 7) are above 40 m. The profiles however, narrowed towards the south while thickness increased. The widening of the beach towards the north is due to longshore transportation of sand from the southern part of the beach and the Good Samaritan which is situated to the south also. The 1968 aerial photographs showed the beach to have a width of about 50 m, suggesting that the northern part of this beach has almost resumed its original profile. The volume was calculated to be about 60 000 m<sup>3</sup> (90 000 tonnes).

### Length of Beaches, Volumes and Tonnage Estimates

The length of each beach, its estimated sand volume and total sand resource estimated as a tonnage is summarised on Table 2 and graphically presented in Figure 7 below.

Table 2. Length of each beach, volumes and tonnages.

Beaches	Length (m)	Volume (m <sup>3</sup> )	Resource as a Tonnage
Laulea	1100	11676	18,000
Lavengatonga-'Oholei -Ha'asini	4400	77915	117,000
Fua'amotu	2500	75970	114,000
'Ahononou	800	27350	40,500
Felekie (Niutoua)	150	296	450
Emeline	400	6315	9,000
Ha'atafu	1500	60394	90,000
Good Samaritan	700	3663	6,000
<b>TOTAL</b>	<b>11 500</b>	<b>263 579</b>	<b>394950</b>

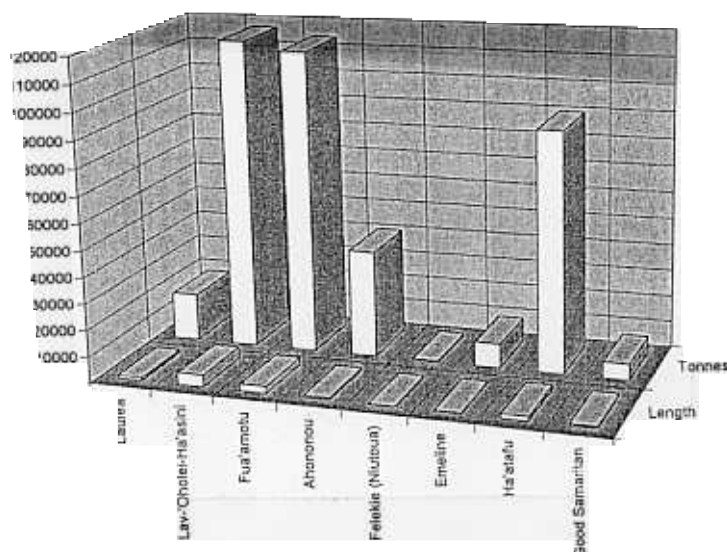

Figure 7. Length of beaches and volume.

## DISCUSSION

### Sand Resources of Tongatapu

The total sand resource from the eight beaches surveyed is estimated to be 394,950 tonnes. Using an average annual consumption of 15 000 tonnes, this supply has a life time of about 26 years. However, two points need to be made. Firstly, about 90% of the volume of sand calculated for the Lavengatonga-'Oholei-Ha'asini Beach tract, lies toward the Ha'asini end (Appendix D2). This is equivalent to about 18% of the total volume of the eight beaches. This portion is however inaccessible for any commercial mining to take place at the moment. Secondly, about 29% of the total volume of sand calculated from the eight beaches is on Fua'amotu Beach. Since it is unlikely in the future that any commercial mining would be allowed in Fua'amotu Beach, due to its proximity to the King's holiday home, the total sand volume needs to be readjusted. There are three scenarios arising out of the above. The first scenario is based on the assumption that all beaches can be made accessible to mining. The second is based on the assumption that Fua'amotu Beach would not be mined and lastly, Fua'amotu and the Ha'asini portion of the Lavengatonga-'Oholei-Ha'asini Beach tract would not be mined in the future. The effects of these on the total sand resource of Tongatapu are summarised in Table 3 below, using the current extraction rate of 15 000 tonnes per annum.

*Table 3. Summary of the three scenarios on the lifetime of sand resources on Tongatapu.*

Scenarios	Tonnes	Lifetime of sand resource
1. All 8 beaches can be mined	394950	26 yrs
2. Fua'amotu can not be mined	277950	18 yrs
3. Fua'amotu and Ha'asini portion can not be mined.	169450	11 yrs

The total volume of sand for Laulea and the Lavengatonga-'Oholei-Ha'asini beach tract is about 117 000 tonnes. This would give a lifetime of about 8 years for the sand resource on this beach tract, using the extraction rate of 15 000 tonnes per annum. This beach tract account for about 30% of the total sand supply for Tongatapu although the extractable volume may be less, as discussed above. Fua'amotu contains about 29%, Ha'atafu contains 23%, 'Ahononou contains 10% and the other 8% is distributed amongst the other three beaches. Fua'amotu Beach has the most sand per square metre followed by Ha'atafu Beach. Ha'atafu Beach has not been mined for the last 12 years while Fua'amotu does not have any recorded commercial mining history.

Figure 8 shows the relationship between the length of the beaches and their volumes. Using Fua'amotu Beach as a reference point because of its relatively pristine state, the following brief discussion is put forward.

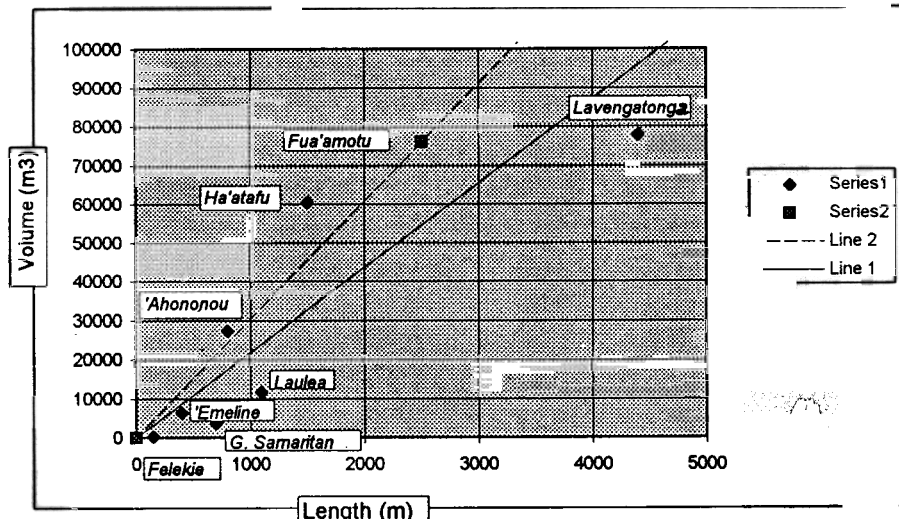

Figure 8. Length of Beaches *versus* Volumes.

Line 1 on Figure 8 represents the line of best fit for the relationship between length of the beaches and volumes. Significantly, Laulea and Lavengatonga which lie below Line 1 have been heavily mined whereas Fua'amotu Beach, relatively untouched, lies above this line. 'Ahononou and Ha'atafu have been heavily mined too in the past but appear to have recovered, in the manner discussed earlier.

Line 2 is drawn through Fua'amotu to represent an optimum condition, since Fua'amotu has not been commercially mined in the past. Significantly, Ha'atafu Beach is found to lie above this line indicating a higher volume for its length. Perhaps Ha'atafu Beach may provide a temporary backstop for sand requirement for the island of Tongatapu in the future, while developing an alternative, like the offshore deposit near Fafa.

The production of carbonate by the fringing reef surrounding Tongatapu has been estimated by Tappin (1993) to be 4 kg/m<sup>2</sup>/yr based on an experiment done by Kinsey and Davies (1979) on the Greater Barrier Reef of Australia. By calculating the total area of the fringing reef surrounding the major beaches, a total of 15 000 tonnes can be produced of which only 50% is envisaged to be able to be cast up onto the beaches. The amount of carbonate being cast up on Laulea and Lavengatonga based on this calculation only amounted to 17% of the total extraction on this sites. This clearly demonstrates that the extraction rate far exceeds the supply. Development on



Tongatapu, in terms of housing and road construction (eg. current Japanese Government roading project) will keep increasing in the future, there is therefore an urgent need to seek alternative sources of sand as the current supply through beach mining is not sustainable at current levels.

### **Effect of Beach Mining**

A profile of a mature beach should show a well-developed berm and a foredune (storm level) above the high water mark and a shoal below the low water mark. While in equilibrium this profile is part of a dynamic system that moves in response to normal waves and those that are generated by storms. During storm conditions the berm and the foredune (storm level) would be reworked into a lower profile. Provided that there is no leakage out of the system (offshore rips and channel) the profile would be rebuilt back to its pre-storm level during normal wave conditions. When mining is carried out on the foredune (berm) and the lower part of the beach, it is considered a leakage out of the system. Unlike storms however, mining provides a net loss to the system. It removes the natural protection of the beach and allows for storm waves to go further inland to get the same amount of volume to build a storm profile. The fast recoveries shown by Ahononou and Ha'atafu beaches appeared to be partly attained this way. Both beaches have shown signs of landward migration with steep scarps on the backbeach areas (Pumice Terrace level). The fresh scarps left on the beaches today are related to Cyclone Kina in January 1993.

In addition to the detrimental interaction of storms and mining activities on the actual beach, other interactions are happening at the same time along the coastline. If the storm only lasted for a short time, the volume required to build a storm profile may not be readily available. This would lead to an unstable state on the beach that needs to be stabilised. The extra volume required for stabilisation would be provided from the beaches along the coastline, most likely up current from the mined beach, under the process of longshore drift. In the case of Laulea and Lavengatonga, on the east coast, this could be supplied from 'Oholei and Ha'asini beach tract (Figure 3). In fact, this is what has happened in 1982, after Cyclone Issac in March of that year. The profile of Lavengatonga shifted inland by about 50 m, as vegetation was cleared by the storm waves (Lewis et al, 1991). 'Oholei Beach recorded a massive loss of sand after this event due to the process of longshore drift which shifted sand to stabilise Lavengatonga Beach. In the case of Ha'atafu Beach replenishment would be at the expense of the Good Samaritan Beach. All this goes to show that there is a multiple effect to beach mining. Once mining has taken place on a beach that was originally stable the whole system becomes unstable, causing redistribution of sand along

the whole coastline. The beaches that are not directly being mined are also being affected and the back beach area of the beach being mined is also under threat.

### **Economic Value of Sand**

Beaches contribute a natural protection to people's property in coastal communities especially when storms strike. A stable unmined beach provides landowners and resort owners with a boundary demarcating where to build. Once this stability is disturbed by something like beach mining, the seaward boundary is removed. In low-lying coastal areas, safeguarding buildings and the investment placed in them means building inland away from the shift of the beach. Resorts, which usually require a lot of investment are especially vulnerable if already built close to the beach. The loss of appeal to tourists of beaches where sand is being removed can have a more inflated dollar value than only the resale cost of the removed sand. Tourists spend a great deal of money to enjoy white sandy beaches on Pacific islands. The current value of a cubic metre of sand removed is T\$12.00. According to information received from the Tourism Council of the South Pacific, Suva, Fiji, the average number of tourists arriving in Tonga is about 23 000 per annum. The average stay is 8 days with an average spending of US \$346. If tourist numbers were to increase by 12% annually as a result of promoting Tonga and its white sandy beaches, then the actual opportunity costs of mining the beach can run into millions of dollars. While tourists can be good for the economy there is still a need to provide good facilities and accommodation for them which also means more sand is needed for the construction industry. While this may be true, it is also undesirable to mine the beaches because of other social and environmental impacts. However, if an alternative source of sand can be found and developed immediately then opportunity costs provided by the tourist may be turned into real dollars.

### **Alternative Source of Sand**

The search for alternative sources of sand has already been documented in a series of reports by the SOPAC Secretariat (discussed under Previous Studies), although there still remains the need for an Environmental Impact Assessment (EIA) to be carried out on the biological assemblages in the area.

A volume of sand estimated to be around four million cubic metres (six million metric tonnes), has been identified offshore, northwest of Fafa Island and 8 km from Queen Salote Wharf. Using an

annual consumption rate of 15 000 tonnes of sand Per Year, this would provide a lifetime of more than 400 years for this deposit.

The sand has already been tested and found suitable for construction purposes (Chandler, 1991). One of the advantages of mining such a deposit would be the lack of the multiple effects that beach mining poses on the surrounding area, due to the lack of a definite coastline. The work of Kitekei'aho and Yeo (1993). in simulating a sediment plume as a result of mining the deposit has provided positive results, in that the mixing in the area will quickly disperse any plume, should there be one generated. The current dispersion pattern mapped by their experiment suggested no major threat to nearby reefs and coastline.

The source is interpreted as a relic beach, with aggregate very similar in composition to those found on the beach of nearby Fafa Island. Mining methods suitable for such a deposit have been described by Lewis et al (1991). The decision to mine this deposit is now in Tongan Government hands.

Developing the Fafa deposit as the alternative source of sand and suspending the current practice of beach mining for sand resources is urgent. Continuing beach mining to satisfy the demand for sand for development projects of Government and individuals where this demand will only increase, and given the critical non-sustainability of sand supply from beach mining is environmentally indefensible and can only be detrimental to long-term and balanced economic growth. Developing Fafa will allow much needed time for the rejuvenation and recovery of the already destroyed beaches. Raising the aesthetic value of the beaches will make them more attractive to visitors and therefore improve Tonga's profile as a tourist destination thereby directly impacting the economic returns from another sector, which will have an associated although indirect demand for more sand resources (eg. to be used in the construction of more resorts).

### **Beach Monitoring**

A beach monitoring program was initiated by the Government of Tonga in the late 1970's with the establishment of its Natural Resources Section. The author was part of this program. Although very little documentation can be found now and baselines established for the profiles by the author in 1978 on Laulea and Lavengatonga were completely lost due to erosion thus confirming the 50 m landward migration on these beaches. The author's original work is available at the Ministry of Lands, Surveys and Natural Resources. This is the first visit of the author since 1977 to the survey sites (Lavengatonga, Laulea) and substantial changes were visible.

This Survey, is the first Since that of Tappin (1993), is an attempt to set up an annual monitoring program for the Kingdom of Tonga. Such a program would facilitate total sand resource calculations and coastline changes.

What is presently lacking in Tonga is an integrated approach to protecting the coastline. If coastal management is to be successful then there needs to be a central body set up to oversee this development.

## **CONCLUSIONS AND RECOMMENDATIONS**

### **Conclusions**

It is cause for alarm to note that the extraction rate, over the past years, of sand from the beaches of Tongatapu far exceeded the estimated production rate of the reef. This has effectively left the beaches and the coastline exposed and vulnerable to storm-wave attack. This was shown clearly in January 1993 when Cyclone Kina caused up to 50 m landward migration of the coastline recorded on Laulea and Lavengatonga beaches.

The delineation of Tongatapu sand resources has showed that about 35% of the total sand resource (394 950 tonnes) is contained in Laulea and Lavengatonga. However the bulk of this sand is found towards the Ha'asini end of this long beach tract. Direct mining of this sand on a commercial basis is difficult at the moment due to lack of proper roading onto the beach. The beach at this end is bordered on the landward side by a steep uplifted reef terrace (4-5 m). In order to access this sand resource proper roading would be required. Furthermore, about 29% of the total sand resource is locked up at Fua'amotu Beach, which at the moment has no history of commercial mining. Since this beach may not be mined in the near future due to its proximity to the King's holiday home, the total sand resource delineated for Tongatapu is adversely affected. The most conservative estimate of the available volume of sand, assuming Fua'amotu Beach and the Ha'asini portion would not be mined, is 169 450 tonnes. This sets the lifetime of the available resource from beach mining on Tongatapu at 11 years. Needless to say, the effect of the total removal of sand from the coastline will be devastating and such a situation should be avoided at all costs. If only half of this volume is to be considered extractable, then the lifetime of the available resource is much lower and aggravates an already critical situation.

The interaction between beach mining and other natural events like a tropical cyclone is of a destructive nature. The beach profile is lowered and then shifted landward at the expense of the

older and higher pumice terrace. Vegetation is also affected and eroded by this landward migration of the coastline, thus exposing farmlands to the effects of sea spray.

The use of state-of-the-art technology, in this case the new SOPAC Sokkia Total Station to delineate sand resources significantly shortens the time span between data collection and analysis. Resurveys can easily be carried out annually in order to establish denser data sets that will aid in, say, the determination of the recovery rates of beaches. It would be useful if mining in either Laulea or Lavengatonga be suspended for some time for the study to be more effective. This study shows that the available sand resources from beach mining **CANNOT SUSTAIN** the demand into even the near future since the production rate of the reef lags far behind the extraction rate.

A later report, will look at comparing this work with Tappin's (1993) data. Research on the life cycles of forams will throw more light on the rate of production of the reef and the reef flats. This in turn is expected to provide a better estimate of the amount of sand that can be removed, if the Government of Tonga decides beach mining to be the only source of sand.

### **Recommendations**

1. Due to the non-sustainability of beach mining in the immediate future, it is recommended that an EIA be conducted on the proposed mining of the sand deposit close to Fafa Island.
2. In order to properly manage the coastline and its resources, it is essential that some guidelines be formulated through an integrated approach by all sectors of the society. Suggested guidelines can be found in a proposal for an "**Integrated Coastal Management for Tonga**", already submitted to Cabinet for consideration (Appendix H). The proposal was a combined effort of heads of government departments, private sector heads and NGO's under the guidance of SOPAC and SPREP. Of supreme importance is the need for all coastal development matters to be referred to a single authority.
3. The resurvey of beaches on Tongatapu should be carried out annually to delineate the recovery rates of the beaches and also a detail study of the processes acting on the coastline.
4. Similar surveys should be initiated in Vava'u and Ha'apai.

## REFERENCES

- Barstow, S. and Haug, O. 1994: The Wave Climate of the Kingdom of Tonga. SOPAC Technical Report 201.
- Candler, G.G., 1991 (Revised 1992). Engineering of building materials in Tonga. Unpublished.
- Cunningham, and Anscombe K.J. Geology of 'Eua and other islands, Kingdom of Tonga: In Scholl, D.W. and Vallier, T.I.; (eds). Geology and offshore resources of Pacific Islands Arcs - Tonga Region, Circum Pacific Council for Energy and Mineral Resources Earth Science Series, V.2: Tulsa, Oklahoma, American Association of Petroleum Geologists.
- Gauss, G., Carter, R. 1982. Tongatapu sand inventory- Investigation of intertidal and shallow water areas North Coast Tongatapu. CCOP/SOPAC Cruise Report 68.
- Kinsey, D.W and Davies P.J., 1979. Carbon turnover, calcification and growth in coral reefs. In Trudinger P.A. and Swaine, D.J., (eds). Biogeochemical cycling of mineral-forming elements, Elsevier, Studies in Environmental Science, 3, P.131 - 162.
- Kitekei'aho, T., Harper, J.R., 1989. High resolution seismic survey for lagoonal sand and gravel resources in Tongatapu, Kingdom of Tonga, CCOP/SOPAC Technical Report 85.
- Kitekei'aho, T., Yeo, G., 1993 Distribution of sand in basin A and investigation of currents northwest of Fafa island, Nuku'alofa Lagoon, Tonga. SOPAC Preliminary Report 59.
- Lewis, K.B., Smith, R.B and Pow, H., 1991. Future sand supplies for Tongatapu: Viability of offshore mining. SOPAC Cruise Report 126, 39p.
- Packham, G.H. 1978: Evolution of a simple island arc: The Lau-Tonga Ridge. In Coleman, P.J. (ed.) Second Southwest Pacific Earth Science Symposium. IGCP Project 110, Sydney, December 1977. Bull. Aust. Soc. Explor. Geophys. 9(3)G2: 133-140.
- Richmond, B.M. 1987. High resolution seismic surveys for lagoonal sand and gravel resources in Tongatapu and Vava'u, Tonga. CCOP/SOPAC Technical report 63.
- Smith, R. B., and Gatliff, R.W., 1991. Assessment of sand resources, north Tongatapu, Nuku'alofa, Tonga. SOPAC Technical report 123, 59p.
- Tappin, D.R. 1993. Beach sand resources of Tonga. British Geological Survey Technical report WC/93/31.
- Tiffin, D. R., 1982. Tongatapu sand inventory, Investigation of intertidal and shallow water areas North Coast Tongatapu. CCOP/SOPAC Cruise Report 68.

APPENDIX A

Depths (in metres) of the Profiles

<b>'AHONONOU</b>					
<b>14-Aug-95</b>					
<i>PROFILE</i>	<i>PUMICE</i>	<i>MID</i>	<i>BERM</i>	<i>LOW</i>	<i>END</i>
<i>NO:</i>	<i>TERRACE</i>	<i>POINT</i>		<i>SLOPE</i>	<i>OF SAND</i>
1	1.76	1.41	1.9	0.33	0
3	0.97	1.56	1.67	0.83	0
5	1.02	1.56	1.46	0.32	0
7	0.63	1.45	1.43	0.35	0
9	0.08	1.01	0.91	0.55	0
10	0.05	0.05	0.44	0.8	0
11	0.053	0.037	0.027	0.37	0
<b>FUA'AMOTU</b>					
<b>15-Aug-95</b>					
<i>PROFILE</i>	<i>PUMICE</i>	<i>MID</i>	<i>BERM</i>	<i>LOW</i>	<i>END</i>
<i>NO:</i>	<i>TERRACE</i>	<i>POINT</i>		<i>SLOPE</i>	<i>OF SAND</i>
1	1.50	0.90	1.40	0.10	0
3	1.42	1.52	1.80	0.20	0
5	1.15	1.45	0.76	0.30	0
7	1.30	1.40	1.16	0.24	0
9	1.54	1.79	0.59	0.20	0
11	2.05	1.83	0.85	0.53	0
13	1.06	1.96	0.89	0.46	0
15	1.53	1.20	1.40	0.30	0
17	1.65	0.78	0.55	0.21	0
19	1.56	1.09	0.50	0.14	0
21	0.80	1.06	0.30		0
23	1.20	0.80	1.00	0.44	0
25	1.50	1.21	0.30		0
27	0.63	0.95	0.3		0

16/8/95

## LAVENGATONGA, OHOLEI, HA'ASINI

<i>PROFILE NO:</i>	<i>PUMICE TERRACE</i>	<i>MID POINT</i>	<i>BERM</i>	<i>LOW SLOPE</i>	<i>END OF SAND</i>
1	0.32	0.3			
2	1.89	1.22	0.55	0.44	0
3	0.33	0.37	0.84	0.09	0
5	0.94	0.05	0.05	0.05	0
7	0.33	0.29	0.92	0.67	0
9	0.37	0.38	1.24	0.96	0
11	0.45	0.83	2.42	0.88	0
13	0.65	1.7	0.94	0.26	0
15	0.97	1.87	1.03	0.25	0
17	0.90	1.29	0.78	0.29	0
19	0.76	0.87	0.36	0.16	0
21	0.26	0.4	0.3	0.35	0
23	1.60	1.1	0.68	0.3	0
25	0.86	1.17	0.9	0.44	0
27	0.61	1.4	0.8		0
29	2.66	0.86	0.25	0.12	0
31	0.84	1.14	0.9	0	0
33	2.03	0.87	0.48	0.24	0
35	2.17	1.26	0.66	0.28	0
37	1.91	1.38	0.82	0.28	0
39	2.01	1.24	0.74	0.27	0
41	0.77	0.98	0.58	0.18	0
43	0.93	0.78	0.38	0.19	0
45	0.9	0.45	0		0
47	0.92	0.5	0.21		0

## LAULEA

15-Aug-95

<i>PROFILE NO:</i>	<i>PUMICE TERRACE</i>	<i>MID POINT</i>	<i>BERM</i>	<i>LOW SLOPE</i>	<i>END OF SAND</i>
1	1.50	0.90			0
3	1.74	1.31			0
5	1.10	0.98	0.54	0.35	0
7	0.88	0.50	1.20	1.35	0
9	0.82	0.93	1.40	1.10	0
11	1.35	0.80	1.08	0.88	0
13	0.57	0.64	0.49	0.43	0
15	0.38	0.40	0.38		0
17	1.40	0.58			0
19	0.82	1.01			0



**EMELINE**

17-Aug-95

<i>PROFILE NO:</i>	<i>PUMICE TERRACE</i>	<i>MID POINT</i>	<i>BERM</i>	<i>LOW SLOPE</i>	<i>END OF SAND</i>
1	0.450	0.230			
3	0.180	0.280			
5	0.180	0.150			
7	1.180	0.900			
9	1.400	1.540	1.250		
11	0.920	1.410	2.050	1.200	0
13	0.920	0.860	0.450		
15	1.270	1.670	0.500		

**FELEKIE**

17-Aug-95

<i>PROFILE NO:</i>	<i>EDGE CLIFF</i>	<i>MID POINT</i>	<i>END OF SAND</i>		
1	0.1	0.2	0		
2	0.77	0.5	0		
3	0.31	0.4	0		
4	0.8	0.44	0		
5	1.22	0.44	0		
6	0.97	0.65	0		

**GOOD SAMARITAN**

<i>PROFILE NO:</i>	<i>PUMICE TERRACE</i>	<i>MID POINT</i>	<i>BERM</i>	<i>LOW SLOPE</i>	<i>END OF SAND</i>
2	0.30	0.26	0.28	0.20	0
4	0.35	0.33	0.26	0.20	0
5	0.57	0.74	0.66	0.19	0
6	0.43	1.03	0.62	0.40	0
7	1.23	0.85	0.94	0.50	0
8	0.38	1.04	0.64	0.25	0

**HA'ATAFU BEACH**

<i>PROFILE NO:</i>	<i>PUMICE TERRACE</i>	<i>MID POINT</i>	<i>BERM</i>	<i>LOW SLOPE</i>	<i>END OF SAND</i>
1	1.10	0.90	1.13	0.34	0
3	0.70	0.51	1.11	0.50	0
5	1.23	0.84	0.35	0.53	0
7	0.73	0.70	0.80	1.11	0
9	0.55	0.64	0.47	0.77	0
11	0.73	0.52	0.70	0.65	0
13	0.54	0.60	0.53	0.38	0
15	0.82	0.91	0.67	0.53	0
17	0.50	0.90	0.50	0.80	0
19	0.36	1.10	0.74	0.42	0

## **APPENDIX B**

### **Sketches to show the Locations of the Control Points**

**B.1 LAULEA BEACH**

**B.2 LAVENGATONGA-'OHOLEI-HA'ASINI BEACH TRACT**

**B.3 FUA'AMOTU BEACH**

**B.4 'AHONONOU BEACH**

**B.5/EMELINE BEACH**

**B.6 FELEKIE BEACH**

**B.7 GOOD SAMARITAN BEACH**

**B.8 HA'ATAFU BEACH**

**B.1 Laulea Beach**

- LEGEND**
- ⬡ Control point
  - Coastline
  - ⋯ Waterline
  - Road, track

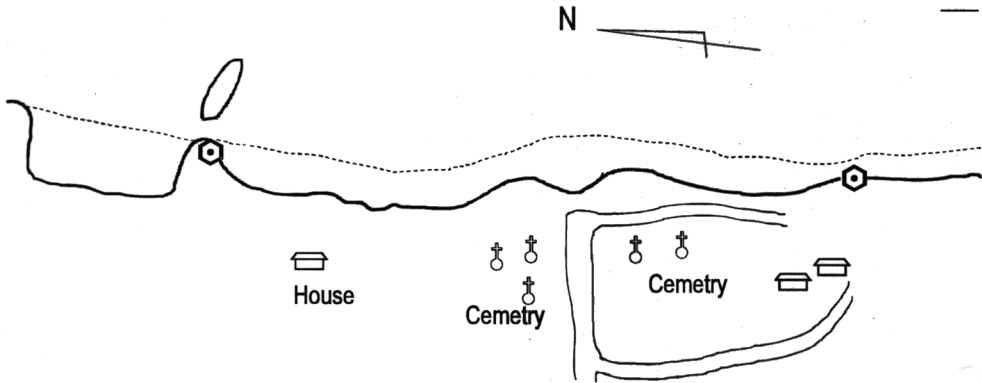

**B.2 Lavengatonga - Oholei - Ha'asini**

**Ha'asini**

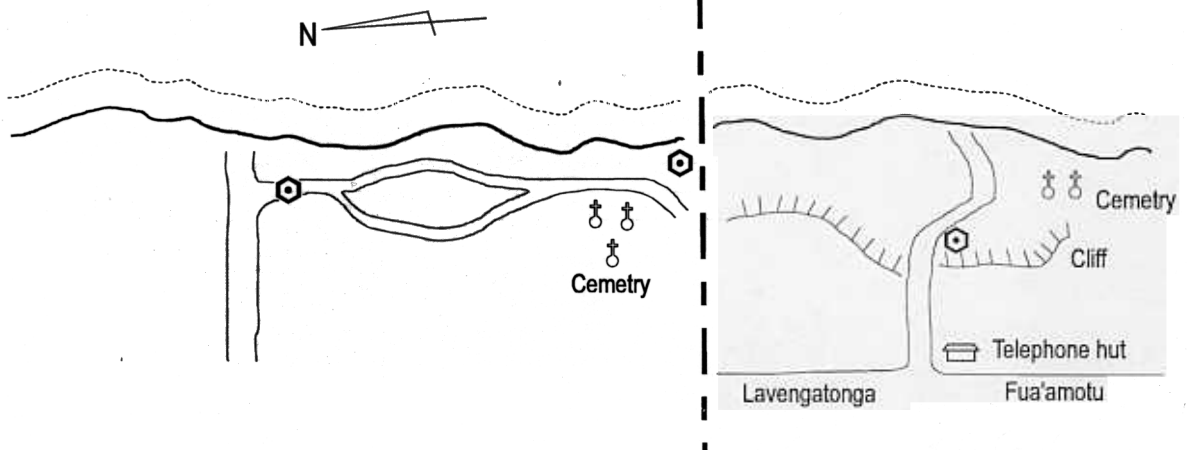

**B.3 Fua'amotu Beach**

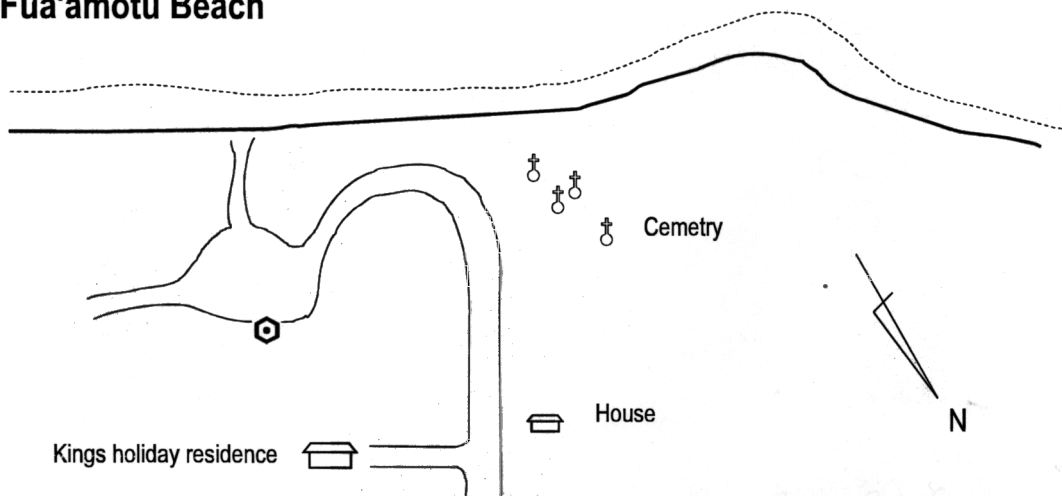

**B.4**

**Ahononou Beach**

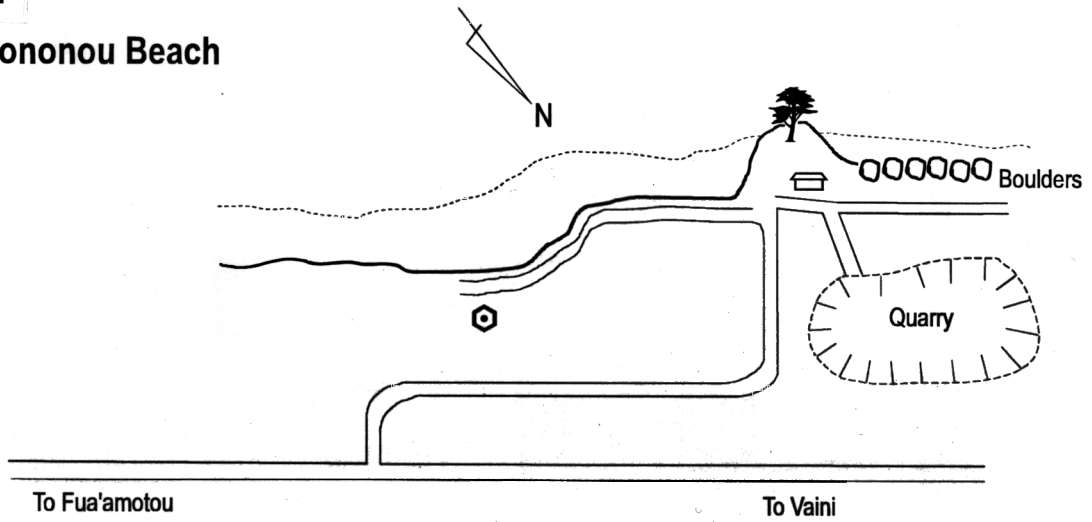

**Emeline Beach**

**B.5**

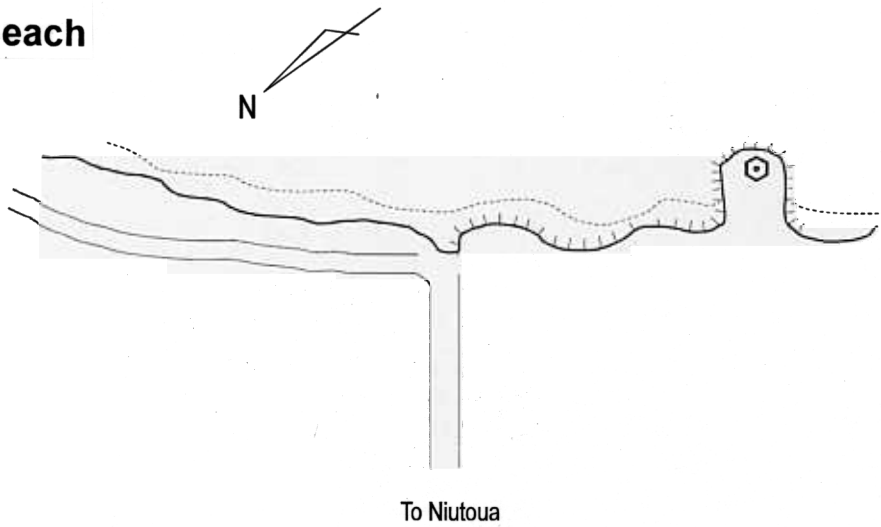

**Felekie Beach**

**B.6**

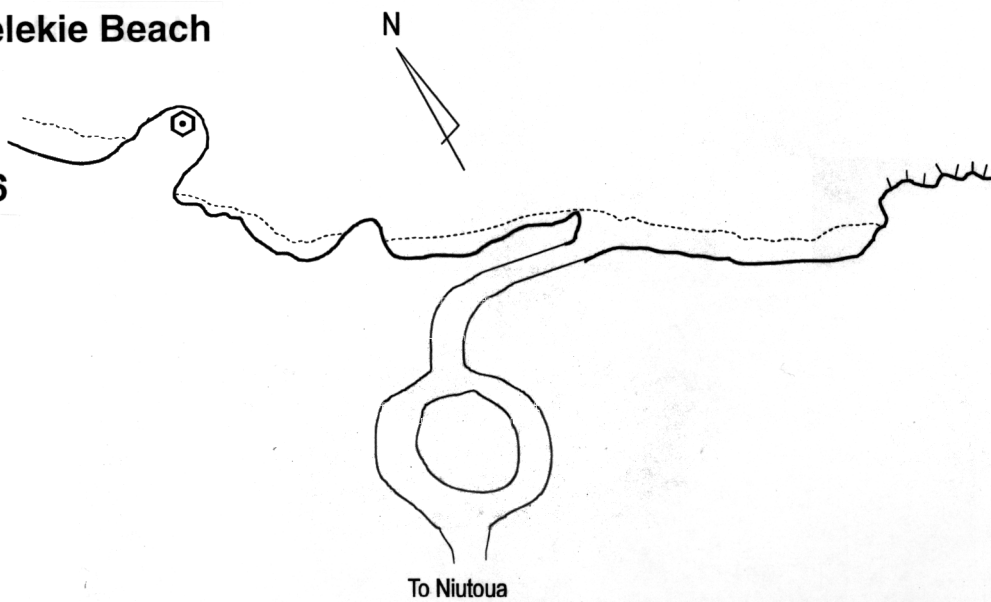

# Ha'atapu Beach

B.8

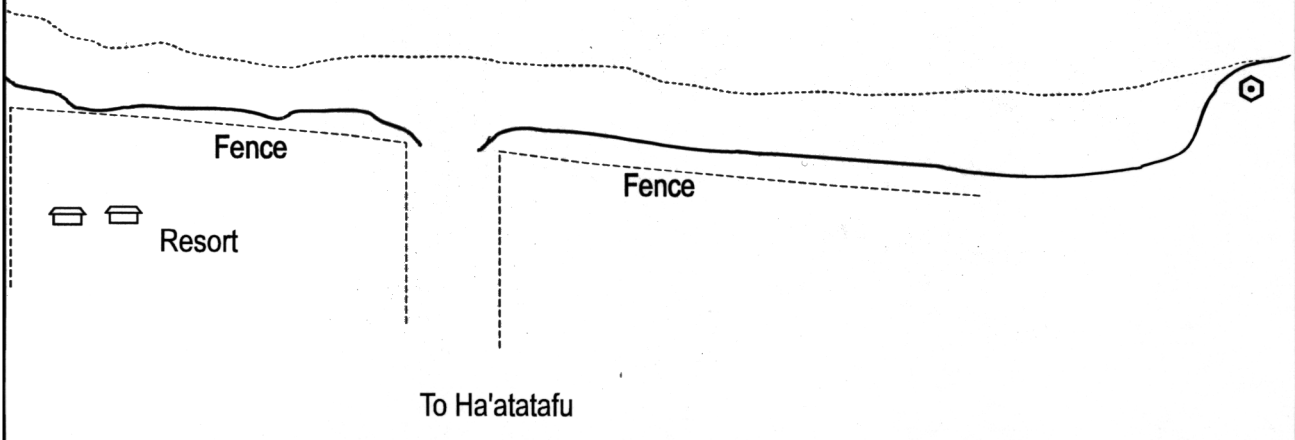
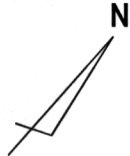

# Good Samaritan Beach

B.7

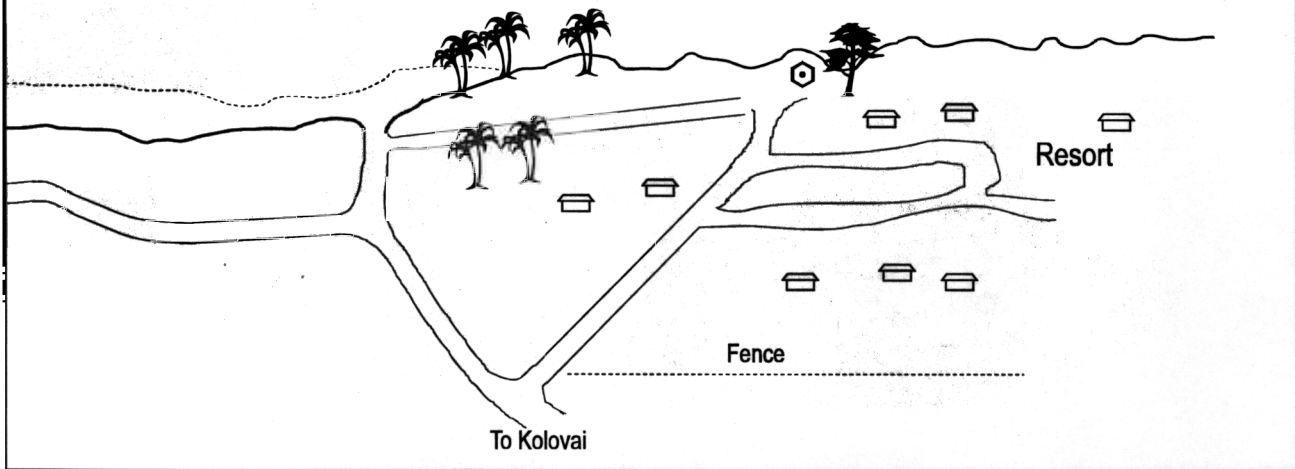

**APPENDIX C**  
**Coordinates of the Control Points**

*TYING OF BEACH PROFILE CONTROL POINTS TO THE NATIONAL GRID (UTM)*

**HA'ATAFU BEACH**

BM	EASTING	:	673,240.915
	NORTHING	:	7,669,253.158
	HEIGHT (Mean Tide)	:	3.44

**GOOD SAMARITAN BEACH**

BM	EASTING	:	670,888.438
	NORTHING	:	7,666,212.182
	HEIGHT (Mean Tide)	:	2.95

**LAULEA BEACH**

BM	EASTING	:	696,691.533
	NORTHING	:	7,652,708.140
	HEIGHT (Mean Tide)	:	3.07

CP	EASTING	:	696,747.076
	NORTHING	:	7,652,371.784
	HEIGHT (Mean Tide)	:	3.80

**LAVENGATONGA BEACH**

BM	EASTING	:	697,262.635
	NORTHING	:	7,650,835.490
	HEIGHT (Mean Tide)	:	4.52

BP71835	EASTING	:	697,344.152
	NORTHING	:	7,650,541.219
	HEIGHT (Mean Tide)	:	4.67

**HA'ASINI BEACH**

BM	EASTING	:	697,085.337
	NORTHING	:	7,648,840.713
	HEIGHT (Mean Tide)	:	8.81

**NIUTOUA BEACH**

BM	EASTING	:	704,039.331
	NORTHING	:	7,660,663.390
	HEIGHT (Mean Tide)	:	2.55

**'EMELINE BEACH**

BM	EASTING	:	702,000.626
	NORTHING	:	7,658,551.120
	HEIGHT (Mean Tide)	:	2.57

**FUA'AMOTU BEACH**

BM	EASTING	:	692,663.690
	NORTHING	:	7,646,800.980
	HEIGHT (Mean Tide)	:	6.68

**'AHONONOU BEACH**

BM	EASTING	:	690,109.367
	NORTHING	:	7,648,138.303
	HEIGHT (Mean Tide)	:	6.70

**NOTE:**

*The National Grid Co-ordinates System is based on UTM Projection Zone 1, International Spheroid (1924) or Hayford Figure.*



**APPENDIX D**  
**Volume Calculations**

*D.1 LAULEA BEACH*

*D.2 LAVENGATONGA-'OHOLEI-HA'ASINI BEACH TRACT*

*D.3 FUA'AMOTU BEACH*

*D.4 'AHONONOU BEACH*

*D.5 EMELINE BEACH*

*D.6 FELEKIE BEACH*

*D.7 GOOD SAMARITAN BEACH*

*D.8 HA'ATAFU BEACH*

**NOTE:** Some problems were encountered with some of the data points on Laulea Beach. The reason is unknown at the moment but the data can be verified on a future survey. This problem resulted in there being no data points diagram included in this report for Laulea Beach and therefore the difference in format in presentation of results for Laulea Beach in this appendix.

## LAULEA BEACH VOLUME CALCULATION

Profile	Elevation	Distance	Dist. Betw	Depth	Area	Average dist	Volume (m <sup>3</sup> )
1	4.43	0	0	1.5			
	3.06	4.41	4.41	0.9	5.29		
	2.07	10.44	6.03	0	2.71		
3	4.57	0	0	1.74			
	3.48	5.94	5.94	1.31	9.06		
	1.67	17.96	12.02	0	7.87	143	1783.00
5	6.03	0	0	1.1			
	4.72	7.54	7.54	0.98	7.84		
	3.69	18.15	10.61	0.54	8.06		
	2.31	27.76	9.61	0.35	4.28		
	1.46	36.04	8.28	0	1.45	115	1701.75
7	2.43	0	0	0.88			
	1.23	2.21	2.21	0.5	1.52		
	0.37	10.04	7.83	1.2	6.66		
	-1.04	25.01	14.97	1.35	19.09		
	-2.71	34.95	9.94	1.35	13.42		
	-3.28	43.09	8.14	0	5.49	105	2424.48
9	0.5	0	0	0.82			
	-0.27	6.11	6.11	0.93	5.35		
	-0.67	14.75	8.64	1.4	10.07		
	-1.5	19.4	4.65	1.1	5.81		
	-2.42	24.71	5.31	0	2.92	139	1678.07
11	-0.81	0	0	1.35			
	-1.44	5.49	5.49	0.8	5.90		
	-1.99	12.02	6.53	1.08	6.14		
	-3.31	20.28	8.26	0.88	8.09		
	-4.33	28.83	8.55	0	3.76	143	1708.62
13	0.27	0	0	0.57			
	-0.06	11.48	11.48	0.64	6.95		
	0.17	24.61	13.13	0.49	7.42		
	0.49	34.49	9.88	0.43	4.54		
	0.04	49.77	15.28	0	3.29	82	909.95
15	0.02	0	0	0.38			
	-0.64	7.26	7.26	0.4	2.83		
	-2.16	15.97	8.71	0.38	3.40		
	-1.7	20.46	4.49	0	0.85	119	421.34
17	-0.04	0	0	1.4			
	-1.37	4.42	4.42	0.58	4.38		
	-2.64	10.98	6.56	0	1.90	96	301.35
19	-1.4	0	0	0.82			
	-2.31	5.86	5.86	1.01	5.36		
	-2.98	11.77	5.91	0	2.98	179	747.01
<b>TOTAL VOLUME</b>							<b>11675.57</b>
							<b>D.1</b>

## VOLUME COMPUTATIONS

### UPPER SURFACE

Grid File:	C:/TONGA/LAVSURF.GRD
Rows:	0 to 32766
Cols:	0 to 32766
Grid size as read:	200 cols by 200 rows
Delta X:	1.81407
Delta Y:	8.54271
X-Range:	696976 to 697337
Y-Range:	7.65046E+006 to 7.65216E+006
Z-Range:	-1.77814 to 10.8082

### LOWER SURFACE

Grid File:	C:/TONGA/LAVERCK.GRD
Rows:	0 to 32766
Cols:	0 to 32766
Grid size as read:	200 cols by 200 rows
Delta X:	1.38693
Delta Y:	7.53769
X-Range:	697022 to 697298
Y-Range:	7.65053E+006 to 7.65203E+006
Z-Range:	-1.20341 to 2.84217

### VOLUMES

Approximated Volume by	
Trapezoidal Rule:	5185.96
Simpson's Rule:	5370.09
Simpson's 3/8 Rule:	5252.66

### CUT & FILL VOLUMES

Positive Volume [Cuts]:	81618.1
Negative Volume [Fills]:	76432.2
Cuts minus Fills:	5185.96

### AREAS

Positive Planar Area (Upper above Lower):	34776.4
Negative Planar Area (Lower above Upper):	48474
Blanked Planar Area:	530450
Total Planar Area:	613700
Positive Surface Area (Upper above Lower):	34987.2
Negative Surface Area (Lower above Upper):	48552.8

## VOLUME COMPUTATIONS

### UPPER SURFACE

Grid File:	C:/TONGA/LAVSURF2.GRD
Rows:	0 to 32766
Cols:	0 to 32766
Grid size as read:	200 cols by 200 rows
Delta X:	10.3317
Delta Y:	10.0503
X-Range:	697205 to 699261
Y-Range:	7.65192E+006 to 7.65392E+006
Z-Range:	-1.57292 to 4.50943

### LOWER SURFACE

Grid File:	C:/TONGA/LAVRCK2.GRD
Rows:	0 to 32766
Cols:	0 to 32766
Grid size as read:	200 cols by 200 rows
Delta X:	9.29648
Delta Y:	8.39196
X-Range:	697353 to 699203
Y-Range:	7.65222E+006 to 7.65389E+006
Z-Range:	-1.19127 to 2.56322

### VOLUMES

Approximated Volume by	
Trapezoidal Rule:	72384.8
Simpson's Rule:	72621.9
Simpson's 3/8 Rule:	72930.7

### CUT & FILL VOLUMES

Positive Volume [Cuts]:	73081.4
Negative Volume [Fills]:	696.598
Cuts minus Fills:	72384.8

### AREAS

Positive Planar Area (Upper above Lower):	13480
Negative Planar Area (Lower above Upper):	1212.72
Blanked Planar Area:	4.10E+06
Total Planar Area:	4.11E+06
Positive Surface Area (Upper above Lower):	13517.4
Negative Surface Area (Lower above Upper):	1214.35

## VOLUME COMPUTATIONS

### UPPER SURFACE

Grid File:	C:/TONGA/FUASURF.GRD
Rows:	0 to 32766
Cols:	0 to 32766
Grid size as read:	100 cols by 100 rows
Delta X:	21.9798
Delta Y:	5.85859
X-Range:	690999 to 693175
Y-Range:	7.64671E+006 to 7.64729E+006
Z-Range:	-1.84152 to 4.60224

### LOWER SURFACE

Grid File:	C:/TONGA/FUAMRCK.GRD
Rows:	0 to 32766
Cols:	0 to 32766
Grid size as read:	100 cols by 100 rows
Delta X:	16.5758
Delta Y:	4.44444
X-Range:	691371 to 693012
Y-Range:	7.64672E+006 to 7.64716E+006
Z-Range:	-1.81543 to 3.0643

### VOLUMES

Approximated Volume by	
Trapezoidal Rule:	76330.9
Simpson's Rule:	75967.5
Simpson's 3/8 Rule:	75611.5

### CUT & FILL VOLUMES

Positive Volume [Cuts]:	83504.6
Negative Volume [Fills]:	7173.69
Cuts minus Fills:	76330.9

### AREAS

Positive Planar Area (Upper above Lower):	39835.8
Negative Planar Area (Lower above Upper):	7873.69
Blanked Planar Area:	1.21E+06
Total Planar Area:	1.26E+06
Positive Surface Area (Upper above Lower):	39975.8
Negative Surface Area (Lower above Upper):	7896.93

## VOLUME COMPUTATIONS

### UPPER SURFACE

Grid File:	C:/TONGA/AHOSURF.GRD
Rows:	0 to 32766
Cols:	0 to 32766
Grid size as read:	200 cols by 200 rows
Delta X:	3.81407
Delta Y:	1.35678
X-Range:	689681 to 690440
Y-Range:	7.648E+006 to 7.64827E+006
Z-Range:	-1.87697 to 5.04272

### LOWER SURFACE

Grid File:	C:/TONGA/AHORCK.GRD
Rows:	0 to 32766
Cols:	0 to 32766
Grid size as read:	200 cols by 200 rows
Delta X:	3.43216
Delta Y:	1.25628
X-Range:	689730 to 690413
Y-Range:	7.648E+006 to 7.64825E+006
Z-Range:	-1.80036 to 3.17628

### VOLUMES

Approximated Volume by	
Trapezoidal Rule:	27356
Simpson's Rule:	27317
Simpson's 3/8 Rule:	27375.6

### CUT & FILL VOLUMES

Positive Volume [Cuts]:	29919.3
Negative Volume [Fills]:	2563.32
Cuts minus Fills:	27356

### AREAS

Positive Planar Area (Upper above Lower):	19323.3
Negative Planar Area (Lower above Upper):	3184.79
Blanked Planar Area:	182422
Total Planar Area:	204930
Positive Surface Area (Upper above Lower):	19375.2
Negative Surface Area (Lower above Upper):	3196.16

## VOLUME COMPUTATIONS

### UPPER SURFACE

Grid File:	C:/TONGA/EMESURF.GRD
Rows:	0 to 32766
Cols:	0 to 32766
Grid size as read:	50 cols by 28 rows
Delta X:	7.77551
Delta Y:	7.77778
X-Range:	701998 to 702379
Y-Range:	7.65856E+006 to 7.65877E+006
Z-Range:	-1.37138 to 2.63764

### LOWER SURFACE

Grid File:	C:/TONGA/EMERCK.GRD
Rows:	0 to 32766
Cols:	0 to 32766
Grid size as read:	50 cols by 28 rows
Delta X:	7.4898
Delta Y:	7.77778
X-Range:	702012 to 702379
Y-Range:	7.65856E+006 to 7.65877E+006
Z-Range:	-1.98034 to 1.40399

### VOLUMES

Approximated Volume by	
Trapezoidal Rule:	6310.8
Simpson's Rule:	6332.62
Simpson's 3/8 Rule:	6301.31

### CUT & FILL VOLUMES

Positive Volume [Cuts]:	6310.8
Negative Volume [Fills]:	0
Cuts minus Fills:	6310.8

### AREAS

Positive Planar Area (Upper above Lower):	2298.1
Negative Planar Area (Lower above Upper):	0
Blanked Planar Area:	77711.9
Total Planar Area:	80010
Positive Surface Area (Upper above Lower):	2303.39
Negative Surface Area (Lower above Upper):	0

## VOLUME COMPUTATIONS

### UPPER SURFACE

Grid File: C:/TONGA/FELSURF1.GRD  
Rows: 0 to 32766  
Cols: 0 to 32766  
Grid size as read: 200 cols by 200 rows  
Delta X: 0.633166  
Delta Y: 0.552764  
X-Range: 704014 to 704140  
Y-Range: 7.66058E+006 to 7.66069E+006  
Z-Range: -3.06378 to 1.10562

### LOWER SURFACE

Grid File: C:/TONGA/FELERCK2.GRD  
Rows: 0 to 32766  
Cols: 0 to 32766  
Grid size as read: 200 cols by 200 rows  
Delta X: 0.58794  
Delta Y: 0.502513  
X-Range: 704022 to 704139  
Y-Range: 7.66058E+006 to 7.66068E+006  
Z-Range: -3.58588 to 0.316629

### VOLUMES

Approximated Volume by	
Trapezoidal Rule:	295.533
Simpson's Rule:	295.193
Simpson's 3/8 Rule:	297.137

### CUT & FILL VOLUMES

Positive Volume [Cuts]: 338.458  
Negative Volume [Fills]: 42.9253  
Cuts minus Fills: 295.533

### AREAS

Positive Planar Area  
(Upper above Lower): 393.73  
Negative Planar Area  
(Lower above Upper): 159.606  
Blanked Planar Area: 13306.7  
Total Planar Area: 13860

Positive Surface Area  
(Upper above Lower): 397.029  
Negative Surface Area  
(Lower above Upper): 160.044



## VOLUME COMPUTATIONS

### UPPER SURFACE

Grid File:	C:/TONGA/SAMSURF.GRD
Rows:	0 to 32766
Cols:	0 to 32766
Grid size as read:	17 cols by 50 rows
Delta X:	12.5
Delta Y:	12.0408
X-Range:	670900 to 671100
Y-Range:	7.66627E+006 to 7.66686E+006
Z-Range:	-1.35826 to 3.23978

### LOWER SURFACE

Grid File:	C:/TONGA/SAMRCK.GRD
Rows:	0 to 32766
Cols:	0 to 32766
Grid size as read:	17 cols by 50 rows
Delta X:	11.3125
Delta Y:	10.4082
X-Range:	670919 to 671100
Y-Range:	7.66635E+006 to 7.66686E+006
Z-Range:	-1.23296 to 2.65946

### VOLUMES

Approximated Volume by	
Trapezoidal Rule:	3613.85
Simpson's Rule:	3627.17
Simpson's 3/8 Rule:	3748.58

### CUT & FILL VOLUMES

Positive Volume [Cuts]:	11774
Negative Volume [Fills]:	8160.2
Cuts minus Fills:	3613.85

### AREAS

Positive Planar Area (Upper above Lower):	15801.5
Negative Planar Area (Lower above Upper):	9258.44
Blanked Planar Area:	92940.1
Total Planar Area:	118000
Positive Surface Area (Upper above Lower):	15812.5
Negative Surface Area (Lower above Upper):	9269.7

VOLUME COMPUTATIONS

UPPER SURFACE

Grid File:	C:/TONGA/HATSURF.GRD
Rows:	0 to 32766
Cols:	0 to 32766
Grid size as read:	200 cols by 200 rows
Delta X:	1.73367
Delta Y:	7.73869
X-Range:	673234 to 673579
Y-Range:	7.66923E+006 to 7.67077E+006
Z-Range:	-5.9892 to 4.27945

LOWER SURFACE

Grid File:	C:/TONGA/HATRCK.GRD
Rows:	0 to 32766
Cols:	0 to 32766
Grid size as read:	200 cols by 200 rows
Delta X:	0.869347
Delta Y:	6.98492
X-Range:	673239 to 673412
Y-Range:	7.6693E+006 to 7.67069E+006
Z-Range:	-4.12613 to 2.48852

VOLUMES

Approximated Volume by	
Trapezoidal Rule:	-60746.6
Simpson's Rule:	-60646.7
Simpson's 3/8 Rule:	-59788.5

CUT & FILL VOLUMES

Positive Volume [Cuts]:	388.803
Negative Volume [Fills]:	61135.4
Cuts minus Fills:	-60746.6

AREAS

Positive Planar Area (Upper above Lower):	700.813
Negative Planar Area (Lower above Upper):	15579.9
Blanked Planar Area:	515019
Total Planar Area:	531300
Positive Surface Area (Upper above Lower):	704.729
Negative Surface Area (Lower above Upper):	15602.3

## APPENDIX E

### Swell and wind sea directions, south of Tongatapu

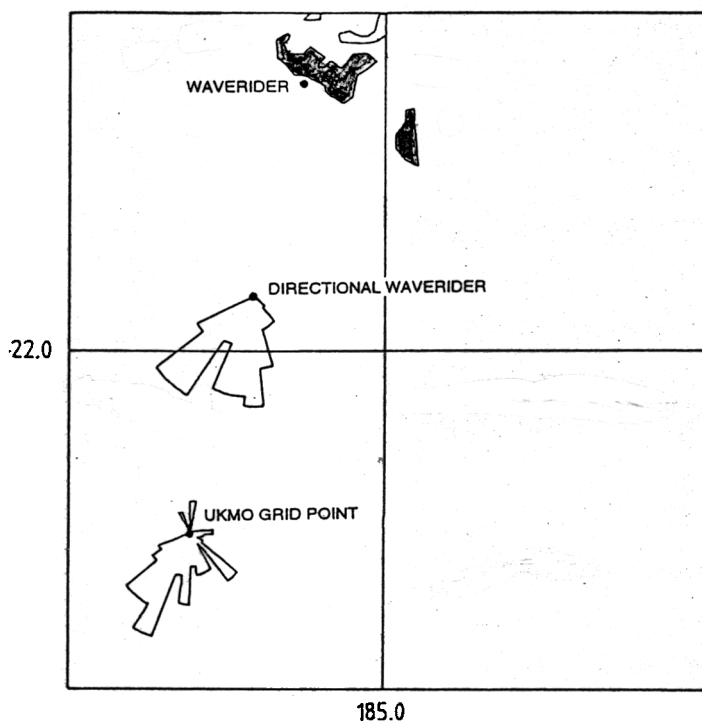

G.1. Swell direction roses for buoy (uppermost) and UK Met. Office wave model.

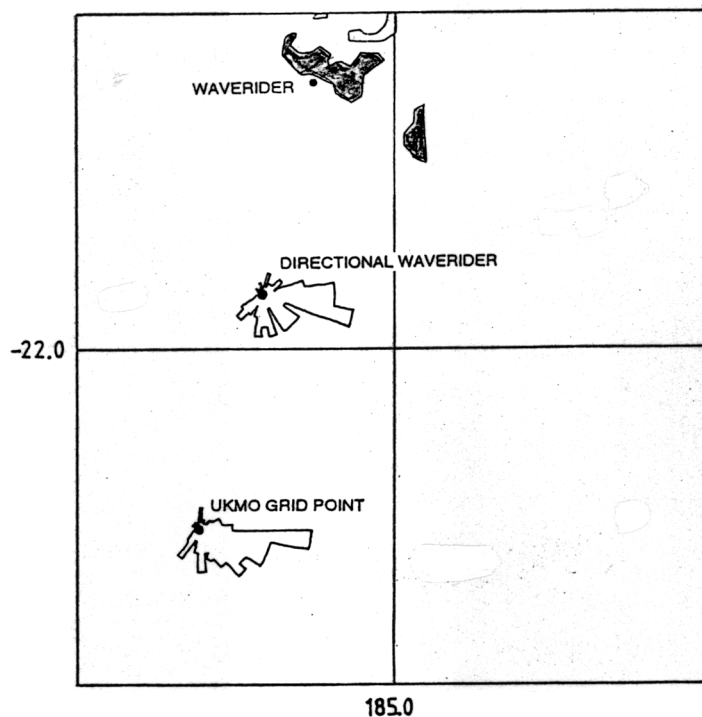

G.2. Wind sea direction for buoy (uppermost) and UK Met. Office wave model.

Note: Taken from Barstow and Haugh 1994. SOPAC Technical Report 201

## APPENDIX F

### Data points and the blanked area use for the volume calculation

*F.1 LAVENGATONGA -'OHOLEI-HA'ASINI BEACH TRACT*

*F.2 FUA'AMOTU BEACH*

*F.3 'AHONONOU BEACH*

*F.4 'EMELINE BEACH*

*F.5 FELEKIE BEACH*

*F.6 GOOD SAMARITAN BEACH*

*F.7 HA'ATAFU BEACH*

**NOTE:** Some problems were encountered with some of the data points on Laulea Beach. The reason is unknown at the moment but the data can be verified on a future survey. This problem resulted in there being no data points diagram included in this report for Laulea Beach.

# LAVENGATONGA-'OHOLEI-HA'ASINI BEACHTRACT

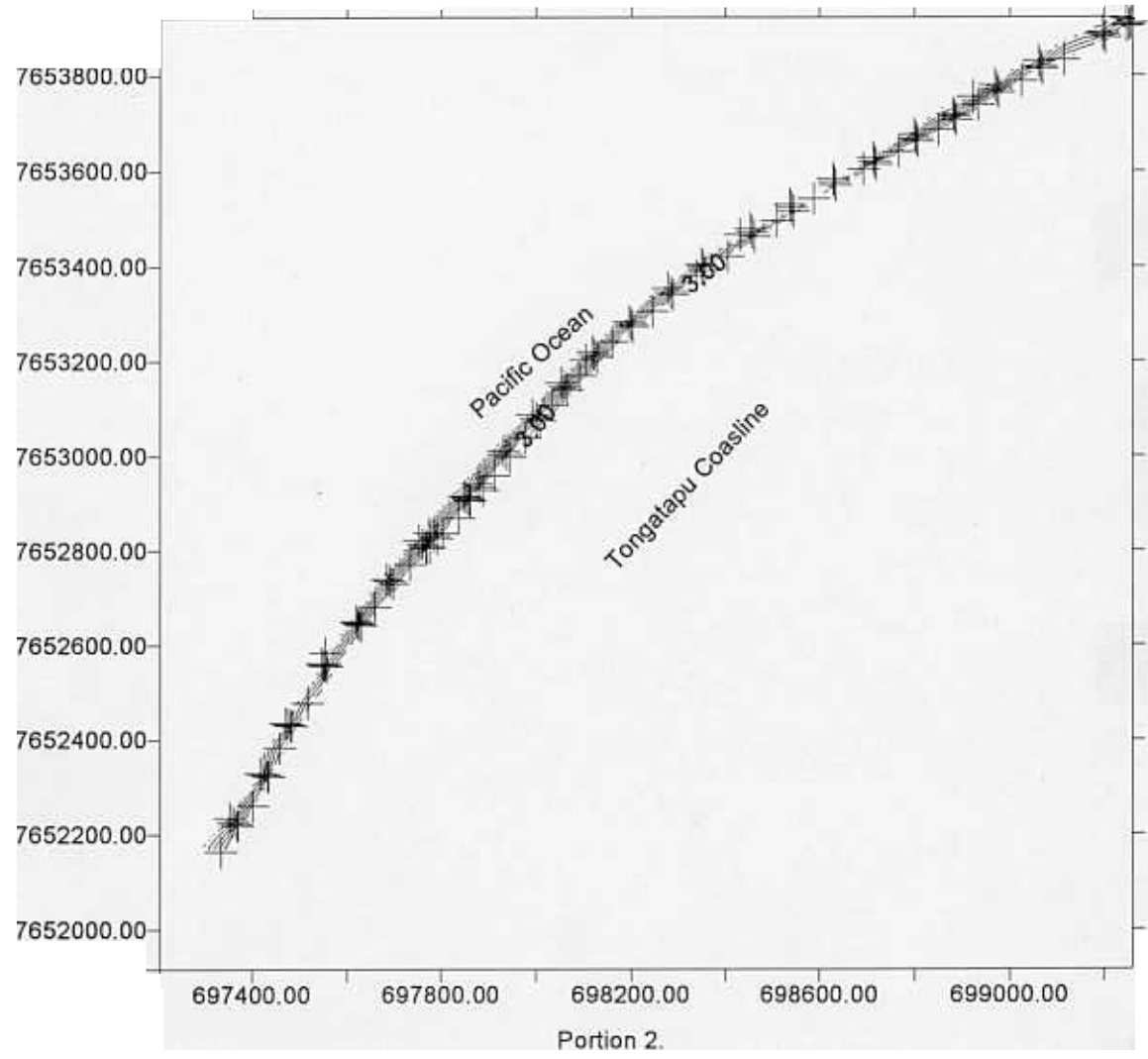
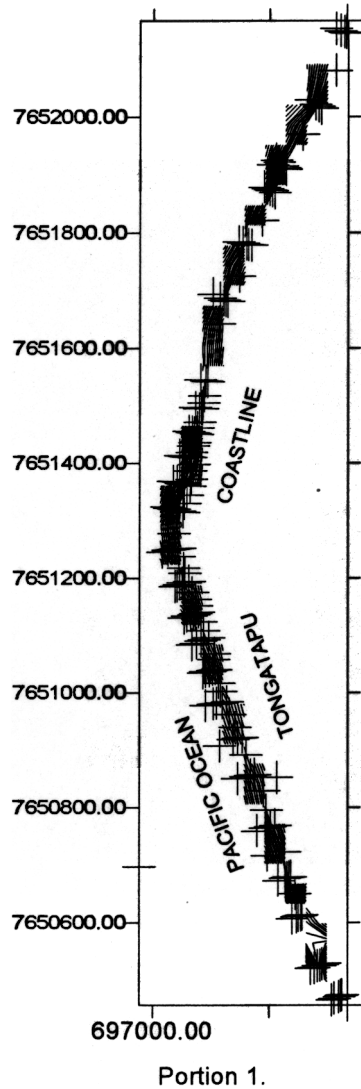

Figure F.1. Contour of two portions of the beach tract. This is the portions used in the volume calculation.  
N.B: Portion 1 represent the northern part of the beach while Portion 2 represent the southern part.

# FUA'AMOTU BEACH

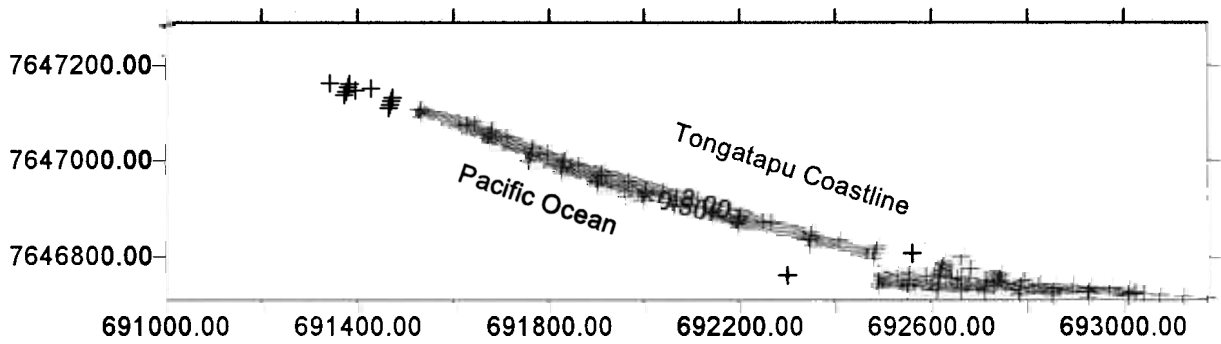

Figure F.2. Contour of the blanked surface topography of the beach. This is the portion used for the volume calculation.

# 'AHONONOU BEACH

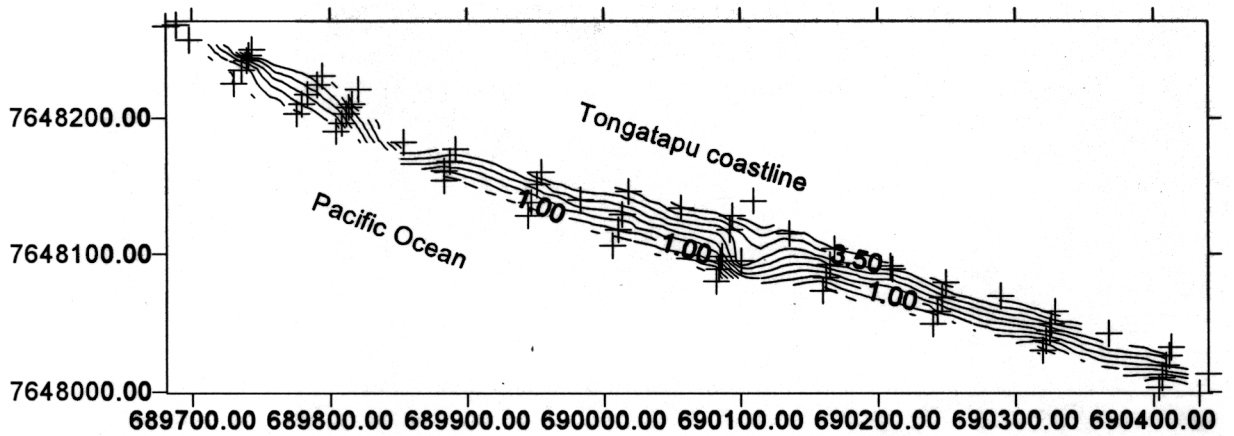

Figure F.3. Contour of the blanked surface topography of the beach. This is the portion used for the volume calculations.

# EMELINE BEACH

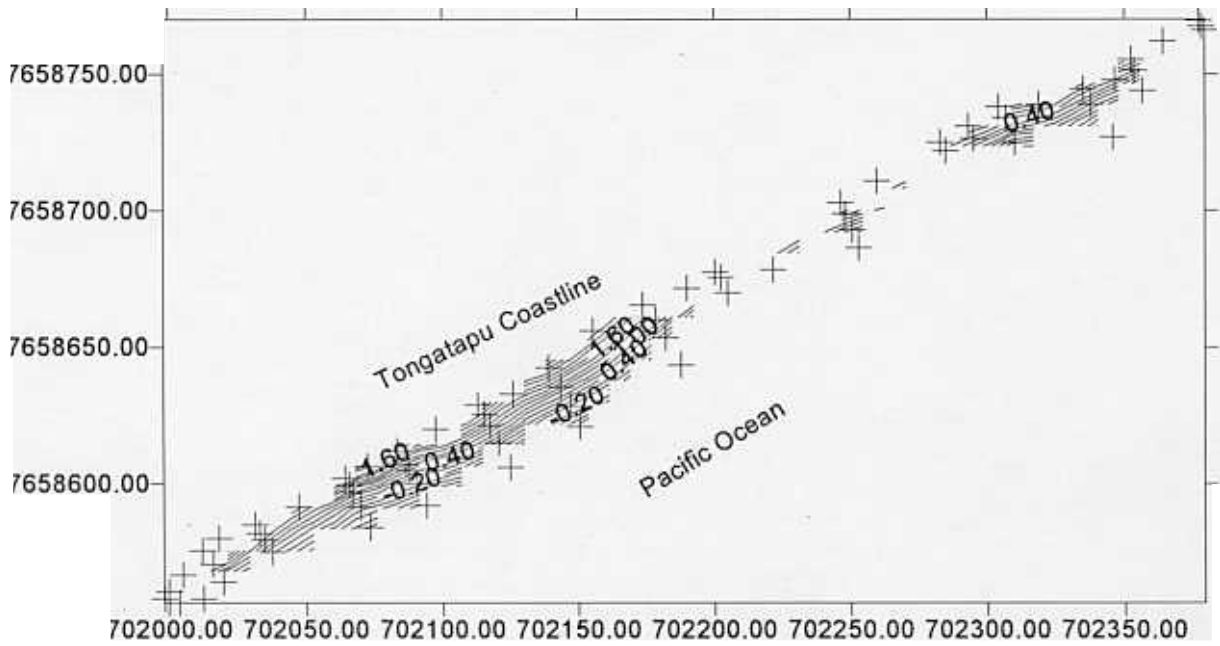

Figure F.4. Contour of the blanked surface topography of the beach. This is the portion used for the volume calculations.



## FELEKIE BEACH (NIUTOUA)

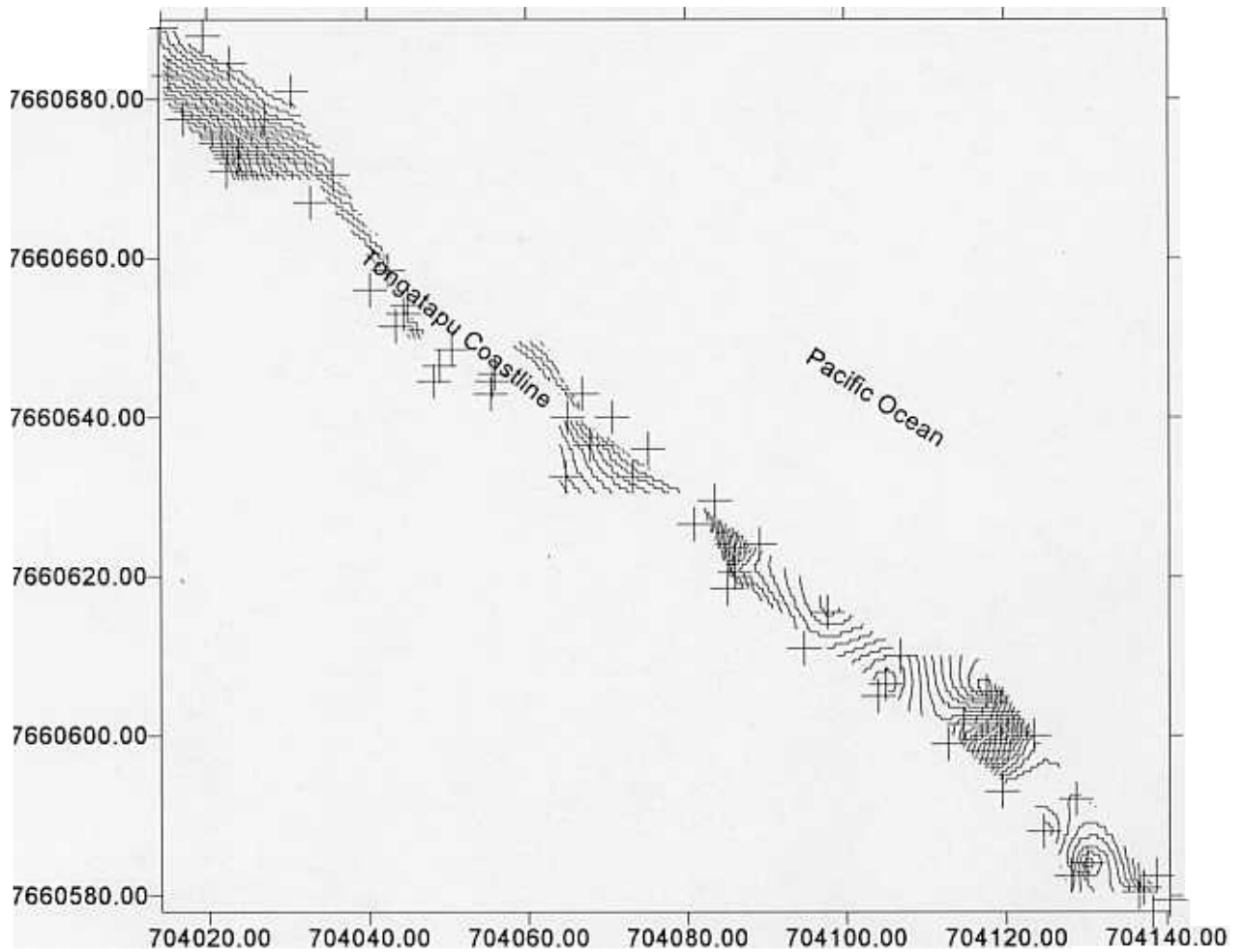

Figure F.5. Contour of the blanked surface topography of the beach. This is the portion used for the volume calculation.

# GOOD SAMARITAN BEACH

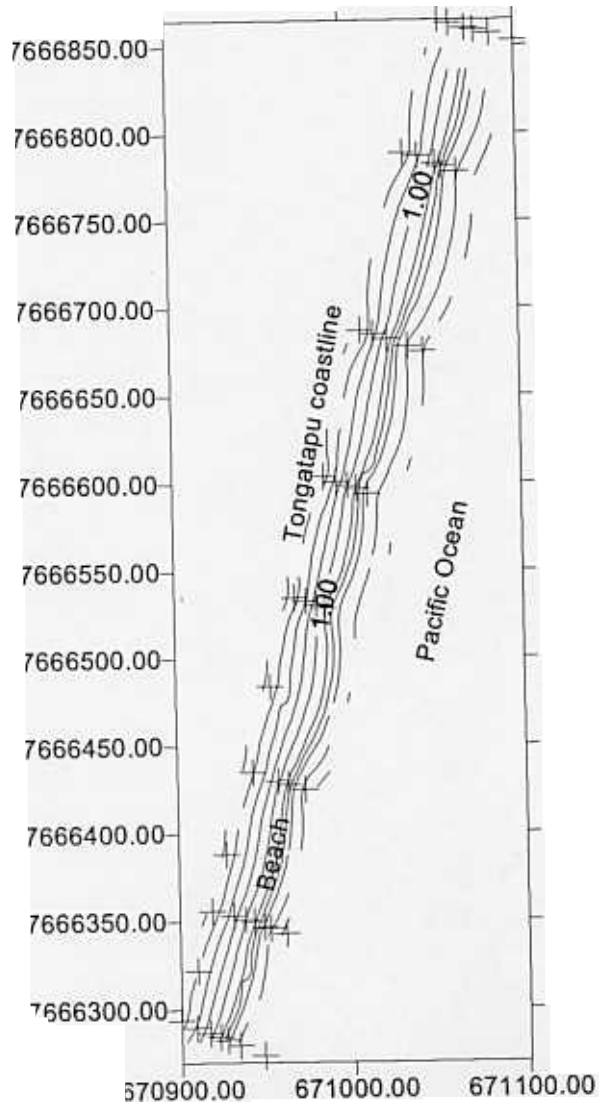

Figure F.6. Contour of the blanked surface topography of the beach.  
This is the portion used for the volume calculation.

# HA'ATAFU BEACH

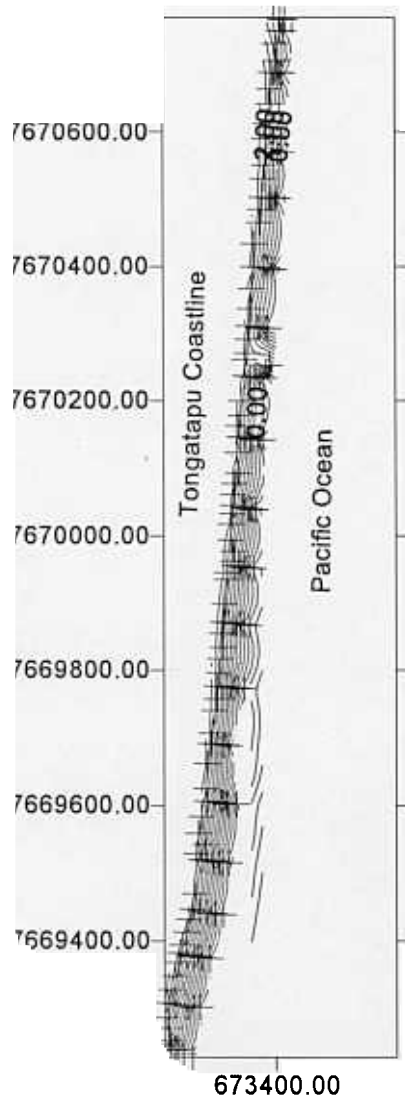

Figure F.7. Contour of the blanked surface topography of the beach. This is the portion used for the the volume calculation..

**APPENDIX G**  
**Representative Profiles of the Beaches**

*G.1 LAULEA BEACH*

*G.2 LAVENGATONGA-'OHOLEI-HA'ASINI BEACH TRACT.*

*G.3 FUA'AMOTU BEACH*

*G.4 'AHONONOU BEACH*

*G.5 EMELINE BEACH*

*G.6 FELEKIE BEACH*

*G.7 HA'ATAFU BEACH*

*G.8 GOOD SAMARITAN BEACH*

# LAULEA BEACH

Profile 1

Dist(m)	Elev(m)
0.00	4.43
4.41	3.06
10.44	2.07

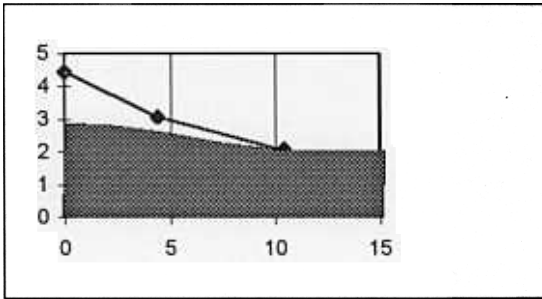

Profile 3

0.00	4.57
5.94	3.48
17.96	1.67

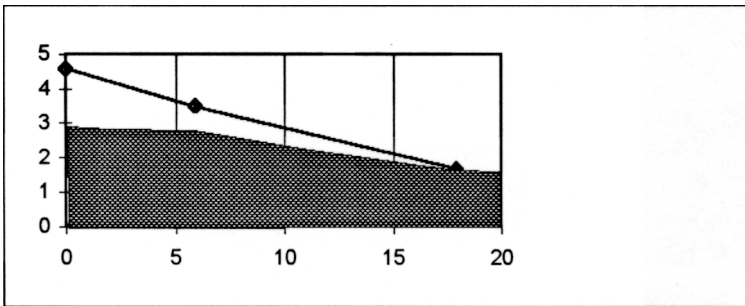

Profile 5

0.00	6.03
7.54	4.72
18.15	3.69
27.76	2.31
36.04	1.46

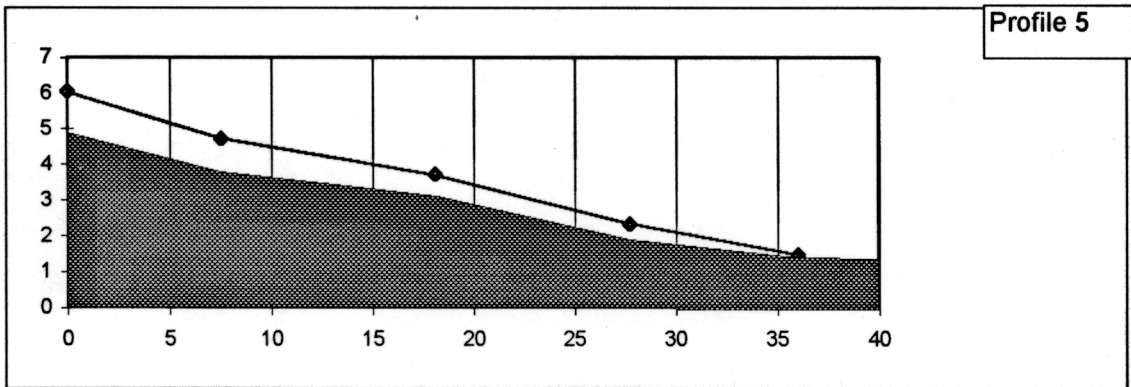

Profile 7

0	2.43
2.21	1.23
10.04	0.37
25.01	-1.04
34.95	-2.71
43.09	-3.28

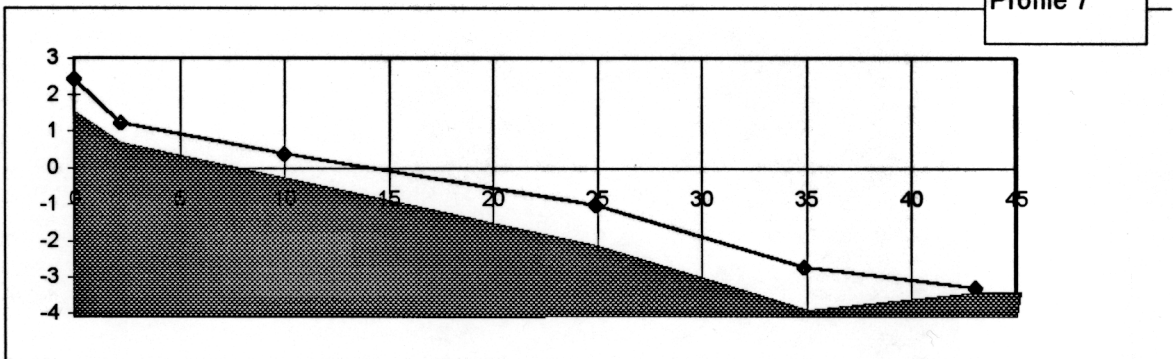

Keys:

- Rock Profile
- Beach Profile

# LAULEA BEACH

Profile 9

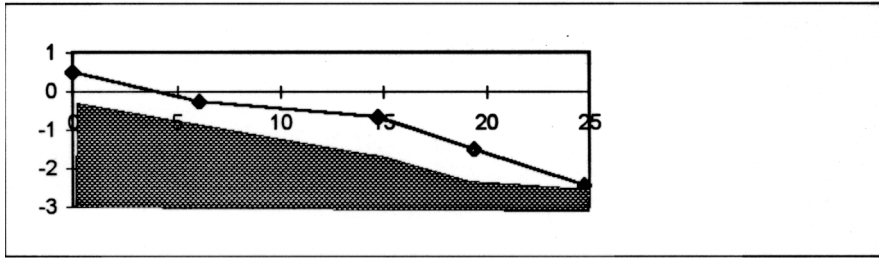

Profile 11

0 -0.81  
 5.49 -1.44  
 12.02 -1.99  
 20.28 -3.31  
 28.83 -4.33

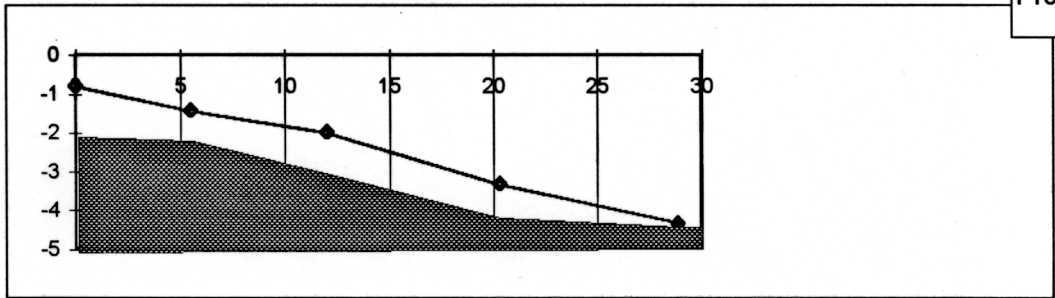

Profile 13

0.27  
 .48 -0.06  
 0.17  
 0.49  
 0.04

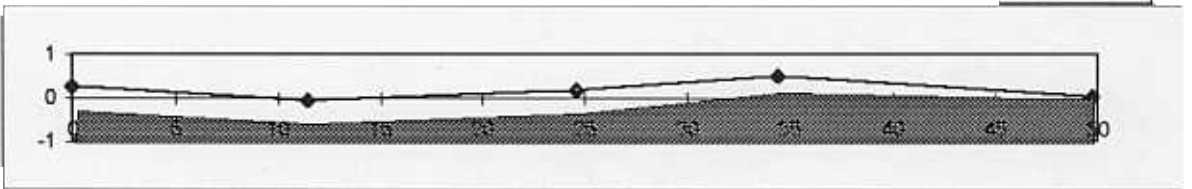

Profile 15

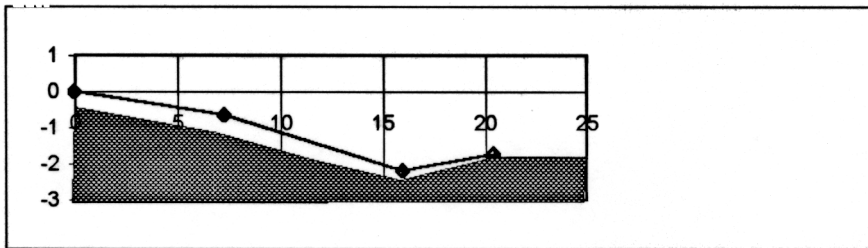

Keys:  
 Rock Profile  
 Beach Profile

# LAULEA BEACH

0	-0.04
4.42	-1.37
10.98	-2.64

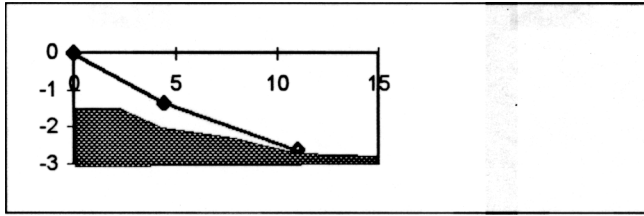

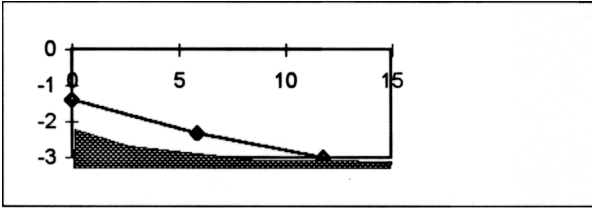

Profile 17

0	-1.4
5.86	-2.31
11.77	-2.98



Profile 19

Keys:

-  Rock Profile
-  Beach Profile

# LAVENGATONGA-'OHOLEI-HA'ASINI BEACH TRACT

Dist	Elev
0.00	1.80
2.95	1.71
6.78	1.71
14.76	0.10
20.39	-0.64

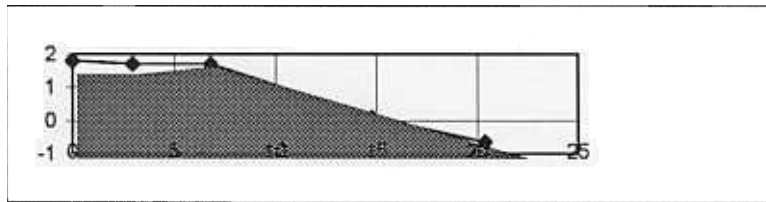

Profile 1

0.00	1.94
4.54	1.27
8.80	0.80
15.13	0.12
21.39	-0.43

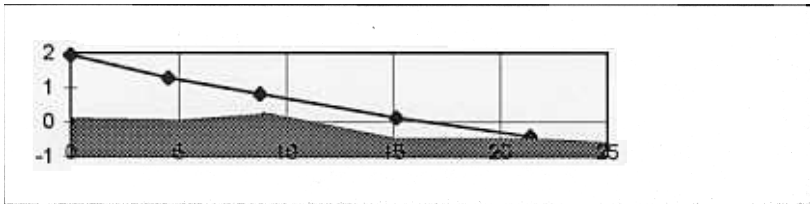

Profile 2

0.00	1.41
4.59	0.49
8.12	0.07
16.61	-0.77

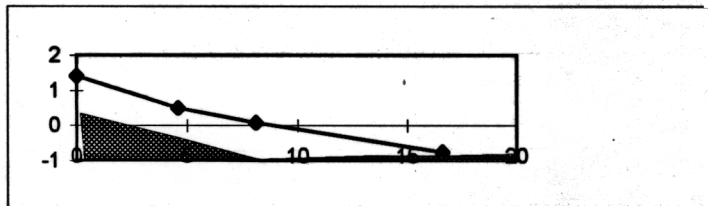

Profile 3

0.00	3.21
8.85	2.29
18.21	1.09

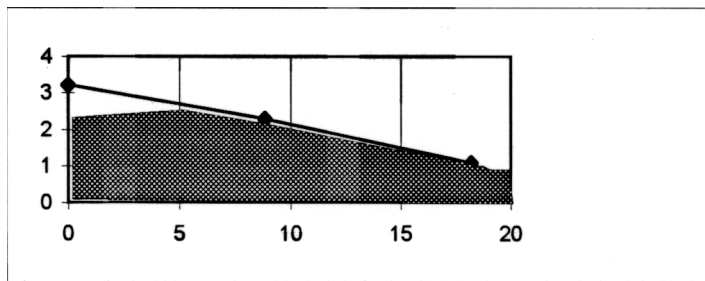

Profile 5

0.00	2.02
7.77	1.77
16.47	1.36

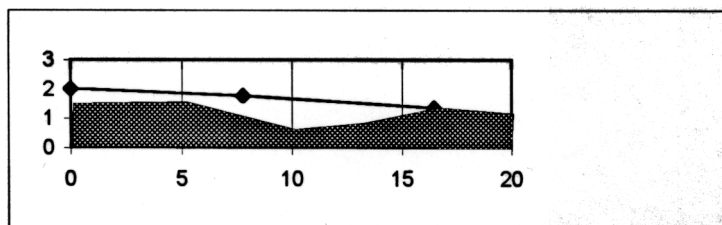

Profile 7

Keys:

- Rock Profile
- Beach Profile



# LAVENGATONGA-'OHOLEI-HA'ASINI BEACH TRACT

0.00 2.08  
 5.17 1.77  
 10.21 1.37  
 17.50 0.20  
 21.95 -0.21

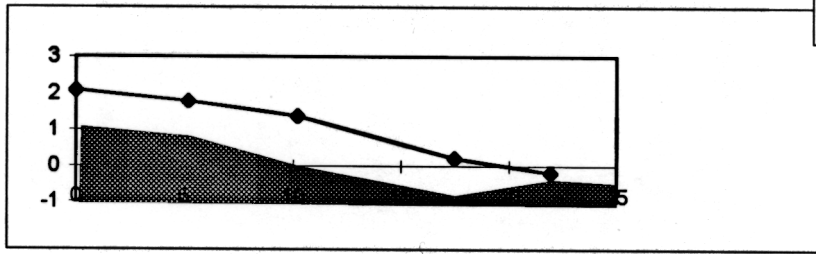

Profile 9

0.00 2.68  
 5.13 2.38  
 8.50 2.14  
 13.87 1.38  
 20.34 0.32

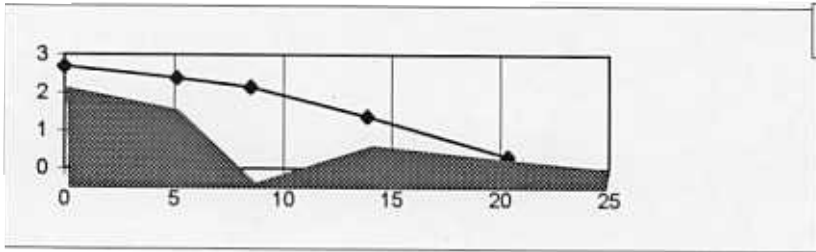

Profile 11

0.00 2.45  
 7.39 2.37  
 13.24 2.27  
 20.15 1.19  
 30.06 -0.11

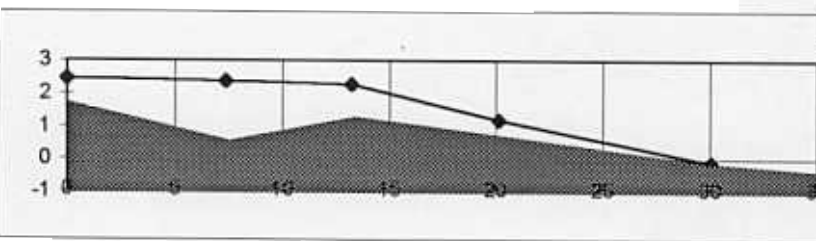

Profile 13

0.00 2.74  
 5.43 2.39  
 8.86 1.42  
 15.77 0.43  
 23.57 -0.32

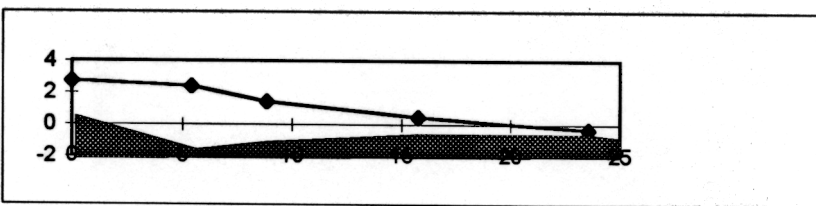

Profile 15

0.00 2.86  
 3.69 2.26  
 9.07 1.29

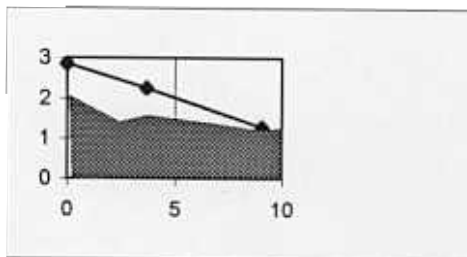

Profile 17

Keys:

- Rock Profile
- Beach Profile

# LAVENGATONGA-'OHOLEI-HA'ASINI BEACH TRACT

Profile 19

0.00 2.33  
3.35 1.87  
10.69 0.72  
19.23 -0.20

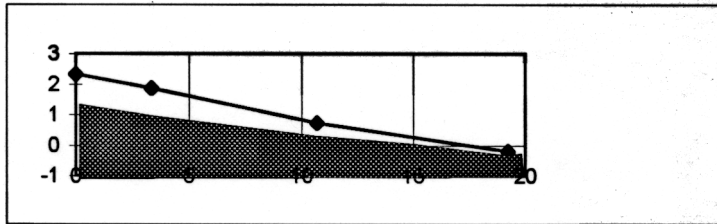

Profile 21

0.00 2.52  
3.71 1.74  
11.50 0.24  
19.08 -0.56

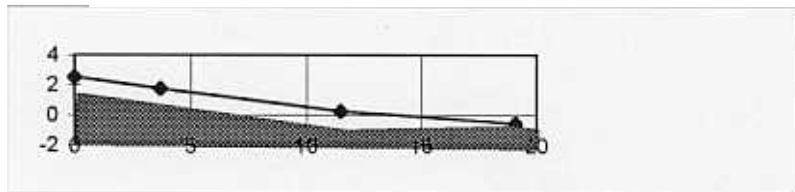

Profile 23

0.00 1.75  
4.03 1.14  
8.87 0.28  
14.70 -0.44

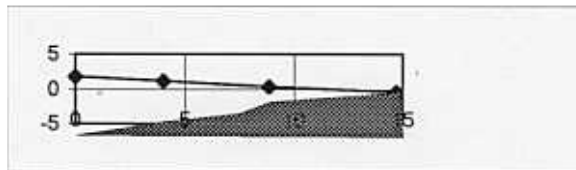

Profile 25

0.00 2.30  
8.69 1.02  
16.76 -0.11

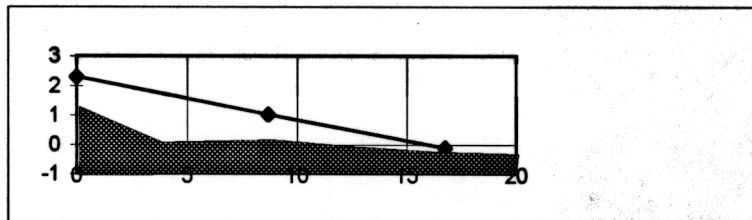

Profile 27

0.00 2.92  
7.63 1.13  
20.67 -0.29

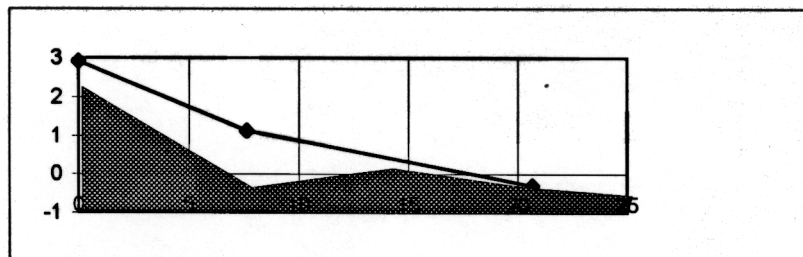

Keys:

- Rock Profile
- Beach Profile

# LAVENGATONGA-'OHOLEI-HA'ASINI BEACH TRACT

0.00 3.59  
 9.26 1.77  
 17.74 0.63

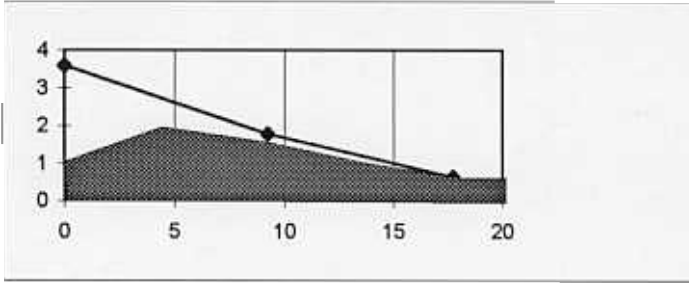

Profile 29

0.00 3.43  
 8.42 1.67  
 20.81 0.11

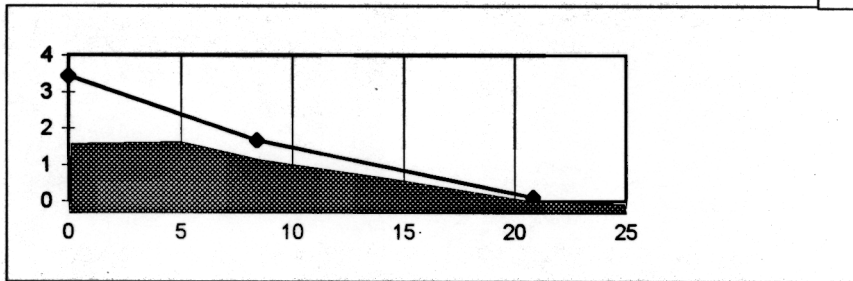

Profile 31

0.00 2.94  
 6.66 1.54  
 13.99 0.58

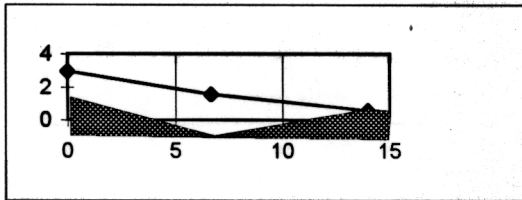

Profile 33

0.00 1.51  
 9.10 0.25  
 10.00 0.00

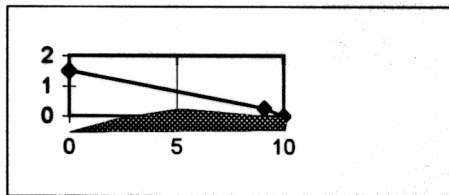

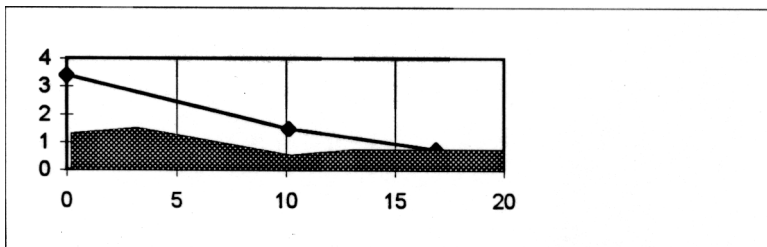

Profile 35

0.00 3.39  
 10.13 1.48  
 16.89 0.75



Profile 37

Keys:

-  Rock Profile
-  Beach Profile

# LAVENGATONGA-'OHOLEI-HA'ASINI BEACH TRACT

Profile 39

0.00 3.49  
8.25 1.88  
16.65 0.69

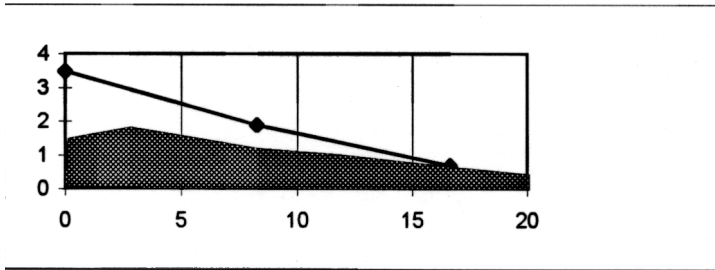

Profile 41

0.00 3.19  
7.13 1.74  
15.65 0.57

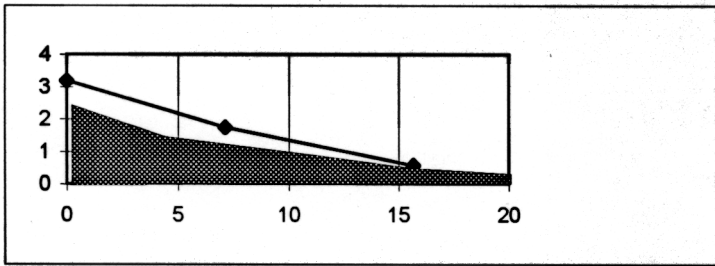

Profile 43

0.00 3.22  
6.94 1.86  
13.61 0.97

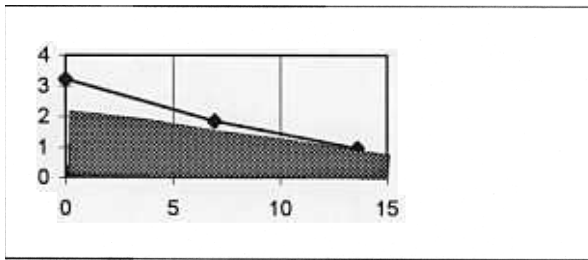

Profile 45

0.00 3.02  
7.47 1.81  
17.87 0.46

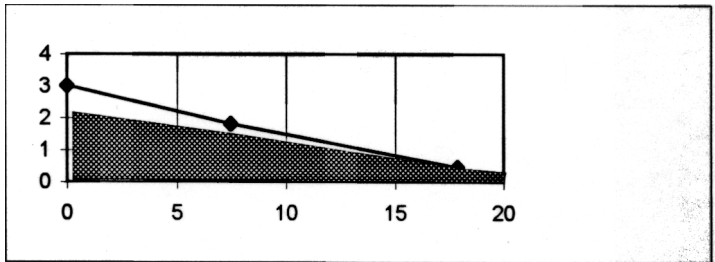

Profile 47

0.00 2.86  
7.30 1.38  
12.51 0.86

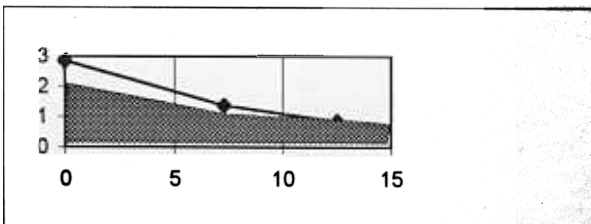

Keys:

- Rock Profile
- Beach Profile

# FUA'AMOTU BEACH

Profile 1

0.00	0.17
4.98	-0.86
10.86	-1.94
16.69	-2.59

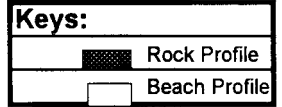
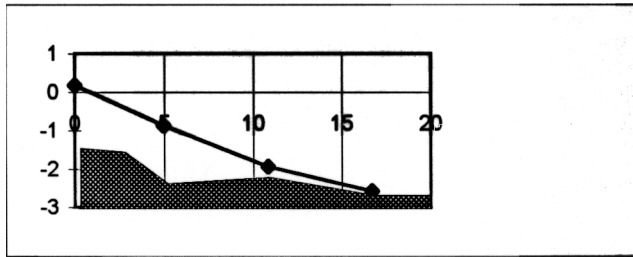

Profile 3

0.00	0.90
5.50	0.24
11.34	-0.65
18.07	-1.79
25.15	-2.76

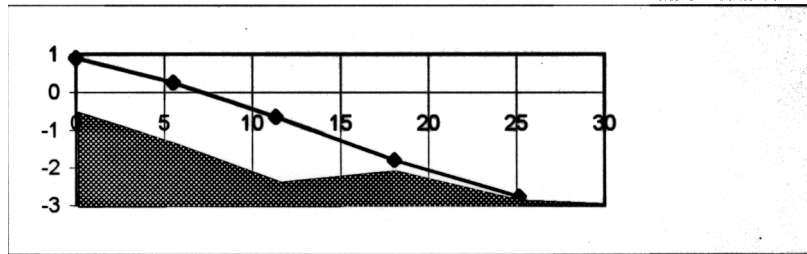

Profile 5

0.00	1.71
6.52	0.50
14.52	-0.93
23.27	-2.42
28.70	-2.99

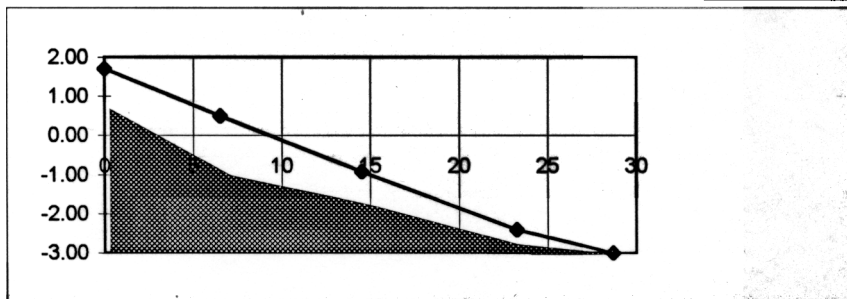

Profile 7

0.00	1.36
6.77	0.49
15.15	-0.46
24.85	-2.11
31.99	-2.96

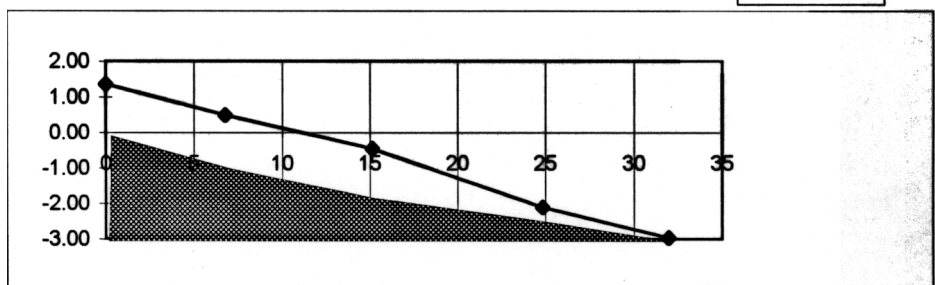

Profile 9

0.00	1.63
5.58	0.55
12.10	-0.70
20.18	-2.08
28.83	-3.07

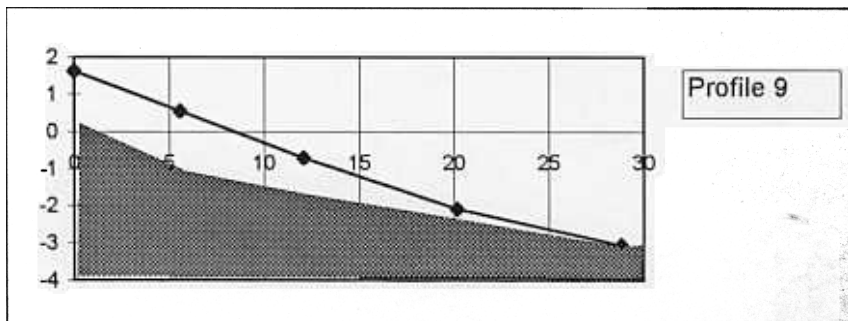

# FUA'AMOTU BEACH

Dist(m)	Elev(m)
0.00	2.97
8.25	1.77
18.46	-0.03
29.51	-1.62

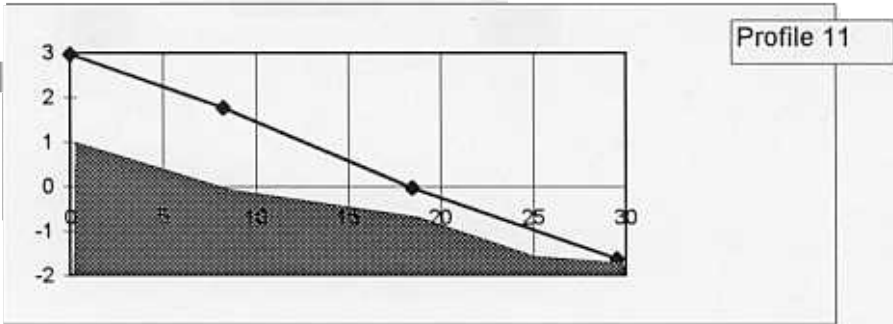

0.00	2.99
7.98	1.86
19.21	0.04
30.35	-1.57

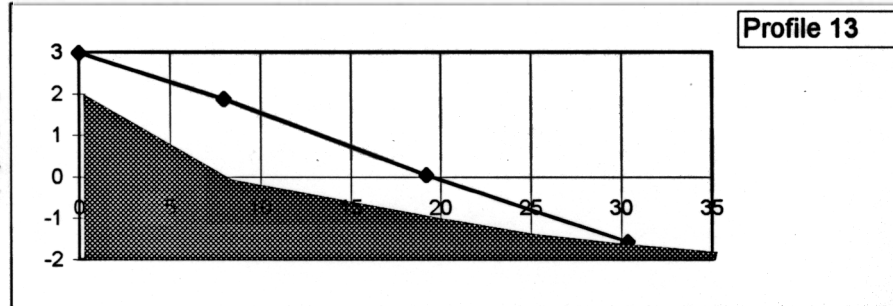

0.00	3.35
6.47	2.23
13.81	0.77
20.58	-0.45
26.73	-1.04

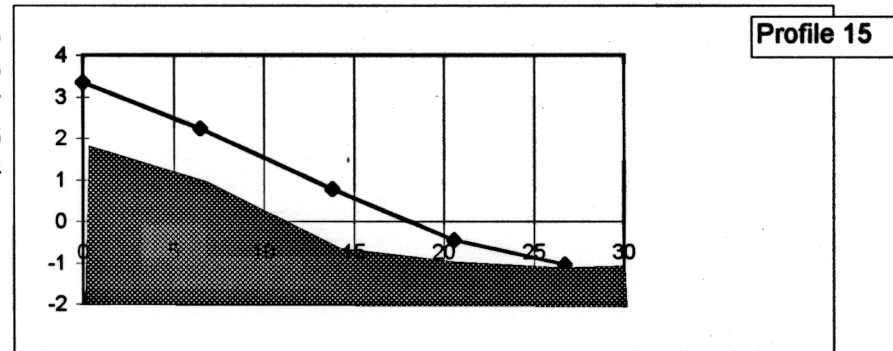

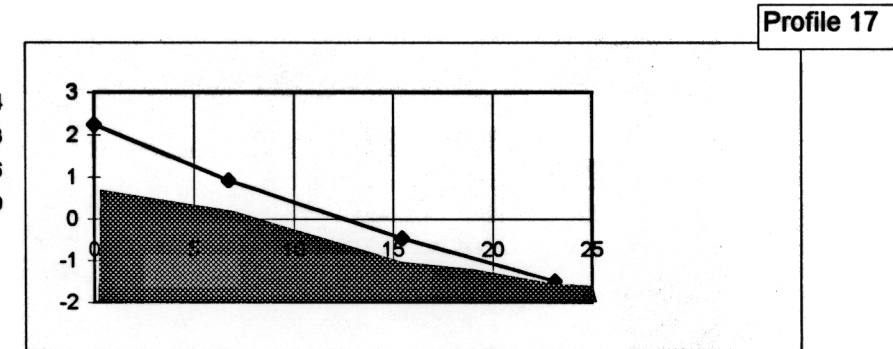

0.00	2.24
6.73	0.93
15.43	-0.46
23.14	-1.49

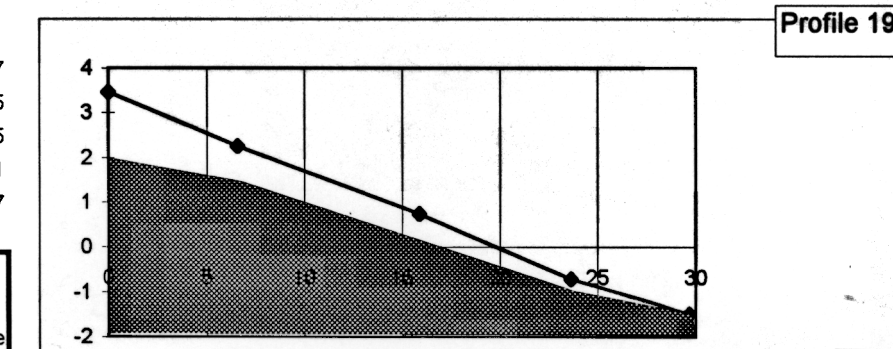

0.00	3.47
6.59	2.25
15.87	0.75
23.64	-0.71
29.67	-1.47



Keys	
	Rock Profile
	Beach Profile

# FUA'AMOTU BEACH

Profile 21

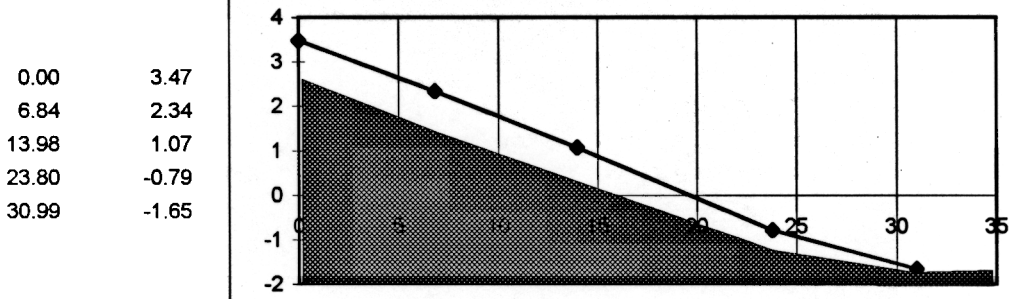

Profile 23

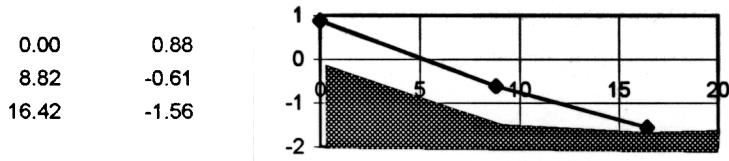

Keys:

- Rock Profile
- Beach Profile

# 'AHONONOU BEACH

Dist	Elev
	1.02
6.11	0.3
13.46	-0.99
23.09	-2.81
30.01	-3.47

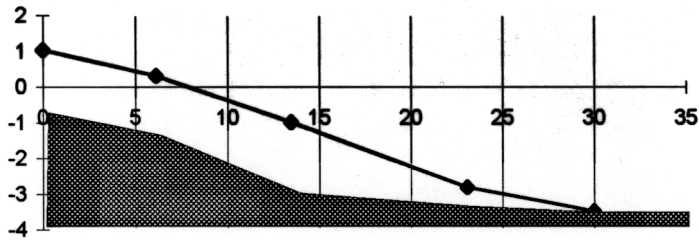

	2.17
11.64	0.54
21.89	-0.8
31.77	-2.18

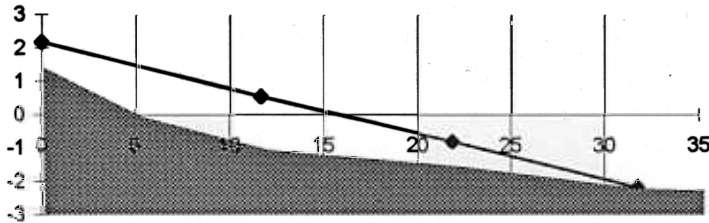

0	2.58
0.32	2.6
10.7	0.98
31.17	0
35.1	-0.9
40.94	-1.74
49.61	-3.1

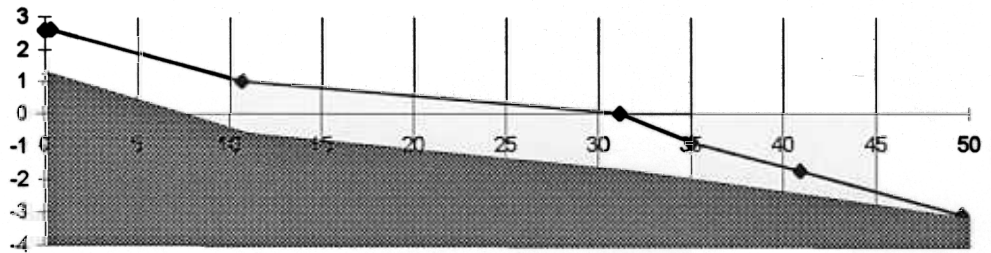

0	2.05
10.25	0.44
23.63	-0.74
33.29	-2.09

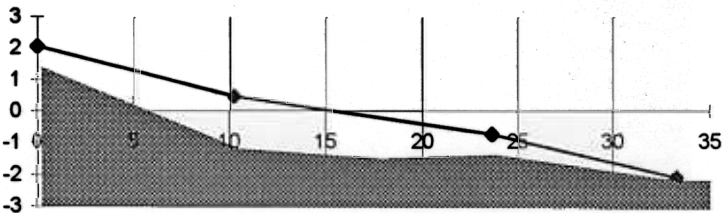

Keys:

- Rock Profile
- Beach profile



# 'AHONONOU BEACH

Dist Elev

0.00	1.24
3.62	-0.18
8.82	-0.63
15.84	-1.10
23.13	-2.19

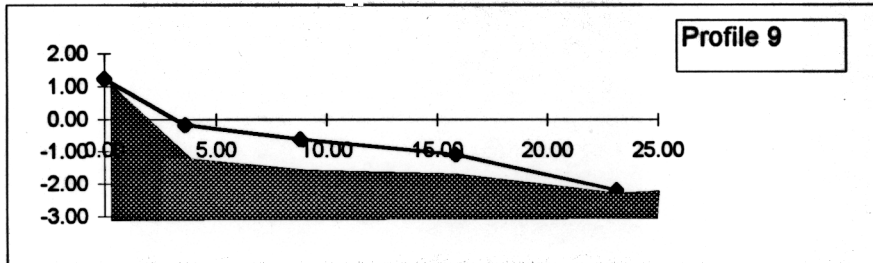

**Profile 10**

0.00	-0.25
9.29	-1.35
17.59	-1.45
25.42	-2.46

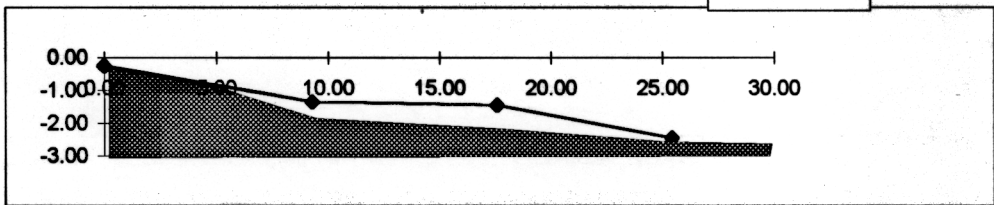

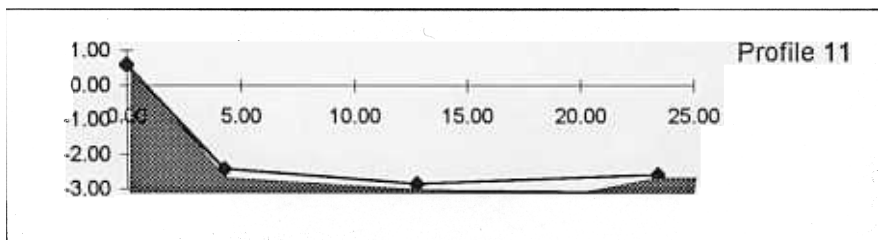

**Profile 11**

0.00	0.58
4.28	-2.41
12.76	-2.85
23.41	-2.59



Keys:

-  Rock Profile
-  Beach Profile

# EMELINE BEACH

Dist (m) Elev (m)

0	-3.44
2.1	-3.86
4.12	-3.97

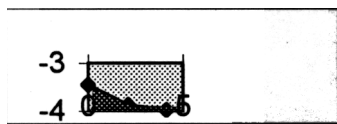

Profile 1.

0	-3
4.05	-3.74
12.02	-5.02

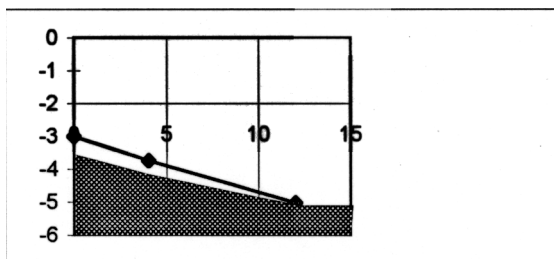

Profile 3

0	-3.54
6.44	-4.39
20.82	-6.1

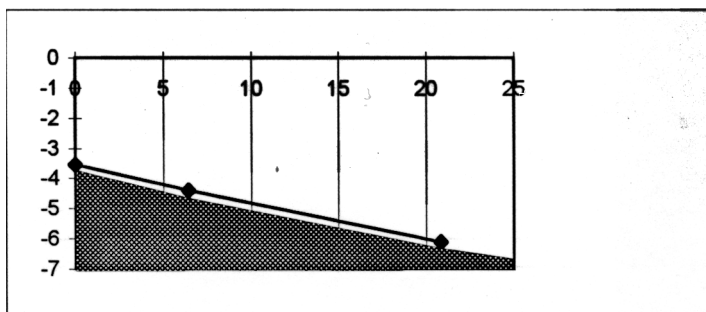

Profile 5.

0	-3.62
4.19	-4.28
10.74	-5.28
17.52	-6.07

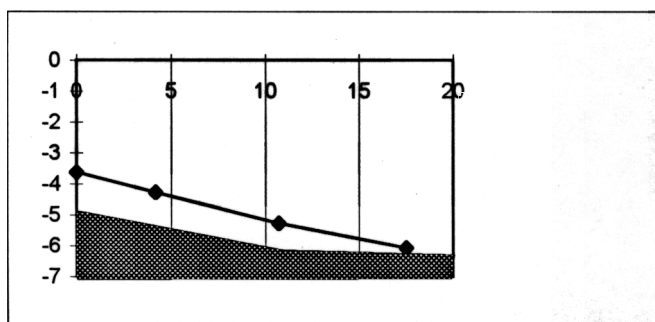

Profile 7

Keys:

■ Rock Profile

□ Beach Profile

# EMELINE BEACH

Profile 9

Dist(m)	Elev (m)
0	-2.19
7.6	-3.22
15	-4.24
26.5	-5.36

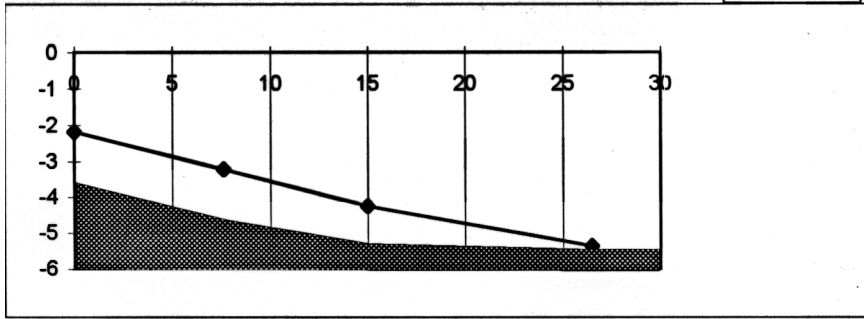

Profile 11

0	-1.81
4.23	-2.64
8.43	-2.96
16.04	-4.04
25.94	-5.71

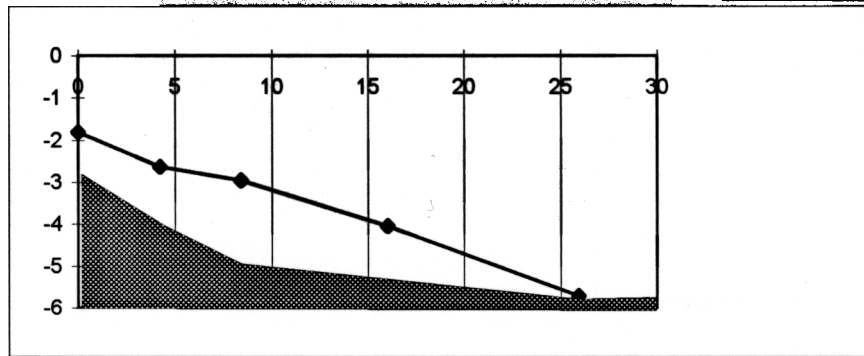

Profile 13

0	-2.3
2.79	-3.05
5.71	-4.11
12.2	-4.69
20.1	-5.41

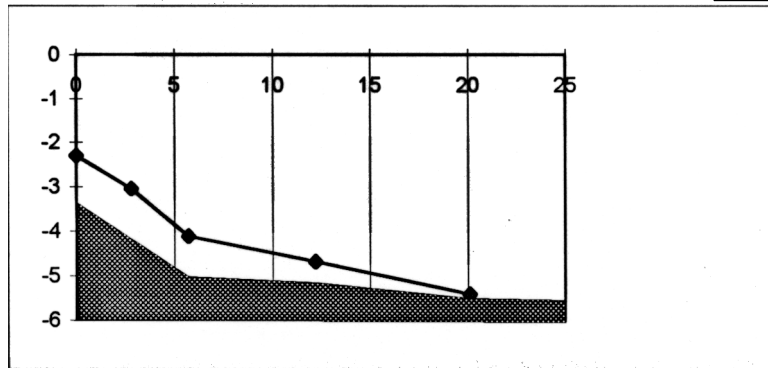

Profile 15

0	-1.77
6.52	-3.13
13.92	-4.2

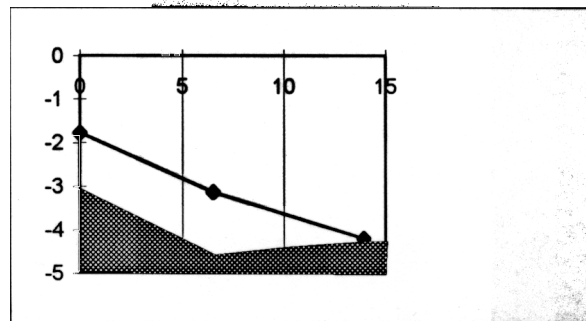

Keys:

 Rock Profile

 Beach Profile

# FELEKIE BEACH

Dist Elev (m)

-0.35

-0.81

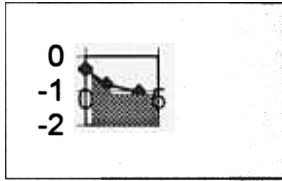

Profile

-2.

7.63

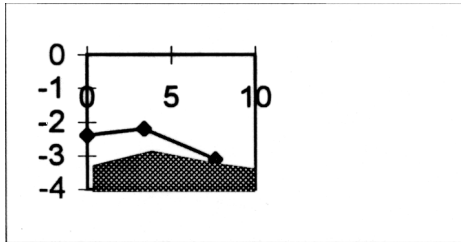

Profile

-2.22

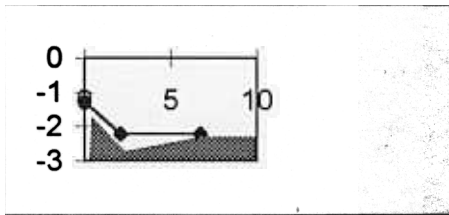

Profile 3

0.40

9.96

-0.68

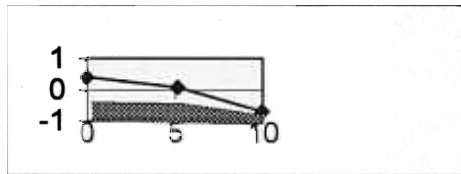

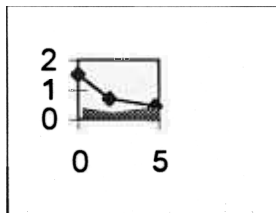

Profile

0.71



Profile

Keys:

-  Rock Profile
-  Beach Profile

7.85

-0.83

12.72

1.23

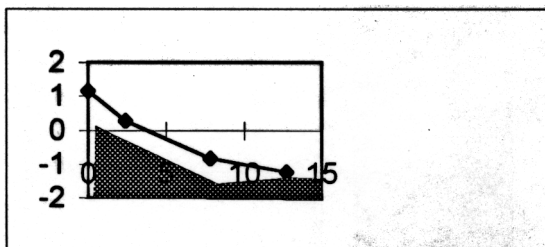

Profile

# HA'ATAFU BEACH

Profile 1

Dist(m)	Elev(m)
0	5.16
11.44	3.61
26.05	2.24
31.22	2.20
38.57	0.58
47.70	-0.44

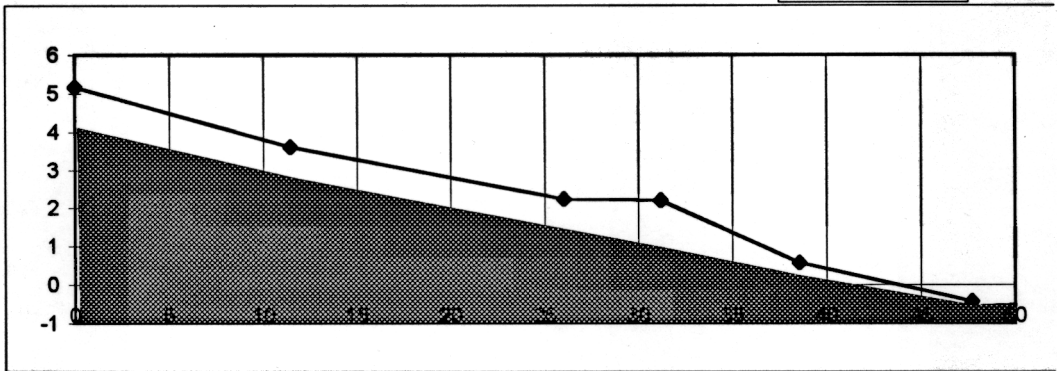

Profile 3

Dist(m)	Elev(m)
0.00	4.37
10.57	3.16
21.56	2.06
27.59	1.10
34.24	0.26
46.29	-0.79

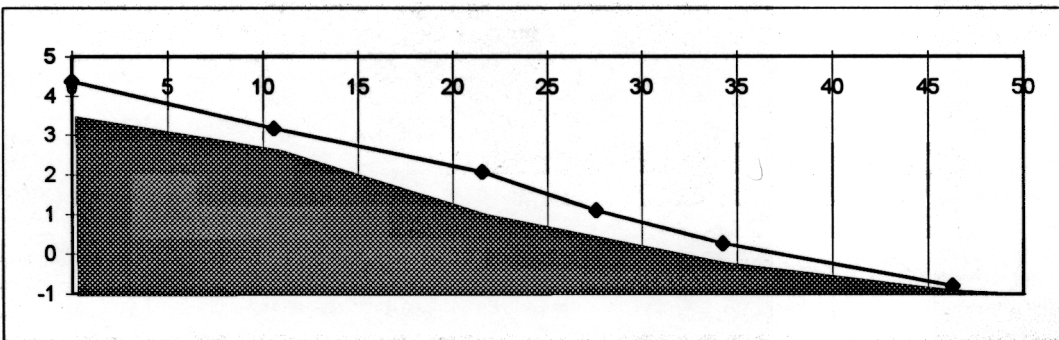

Profile 5

Dist(m)	Elev(m)
0.00	4.53
10.20	3.35
18.87	2.39
22.80	2.31
27.59	1.31
30.59	0.79
43.73	-0.82

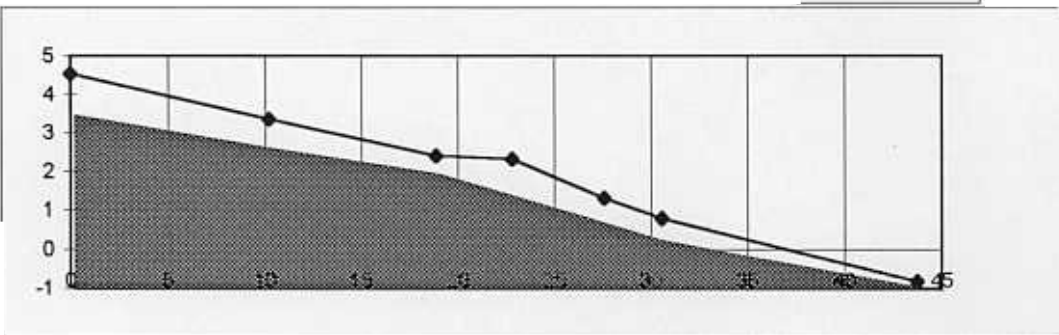

Profile 7

Dist(m)	Elev(m)
0.00	4.34
6.85	3.35
14.07	2.38
18.87	2.14
24.54	1.05
30.21	0.18
39.49	-0.64

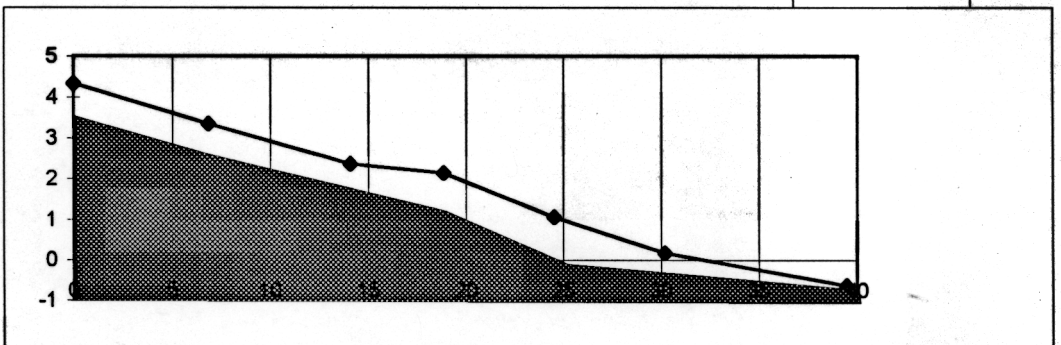

Keys:

- Rock Profile
- Beach Profile

# HA'ATAFU BEACH

Profile 9

Dist(m) Elev(m)

0.00	3.83
6.66	3.10
13.09	2.33
18.26	2.17
25.15	0.82
31.08	-0.10
38.62	-0.55

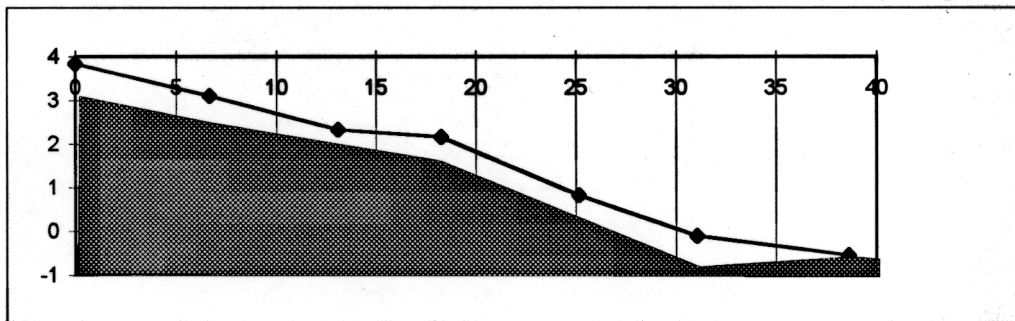

Profile 11

0.00	4.19
13.29	2.56
17.10	2.36
22.75	1.41
28.07	0.45
33.61	-0.19

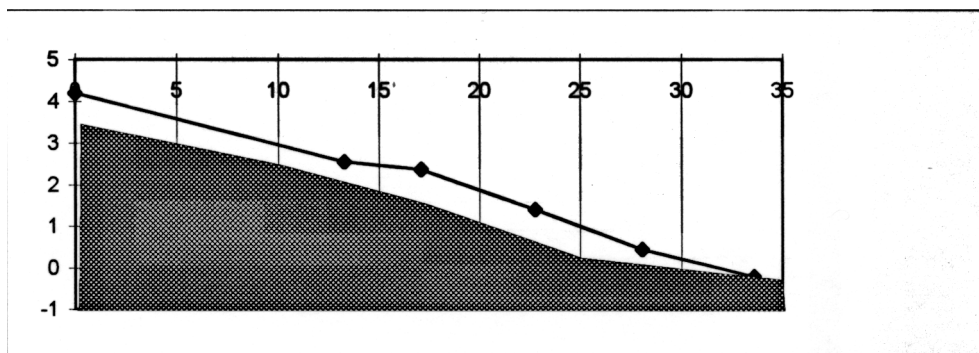

Profile 13

0.00	4.17
6.86	3.31
16.19	2.29
20.32	2.18
29.16	0.52
34.47	-0.12

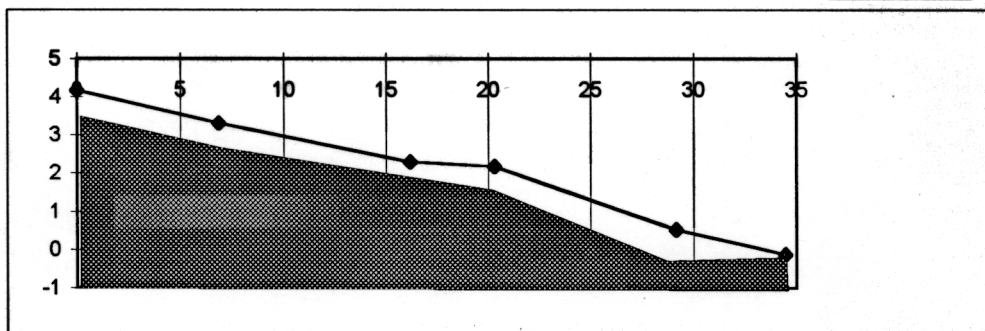

Keys:

- Rock Profile
- Beach Profile

# HA'ATAFU BEACH

Profile 15

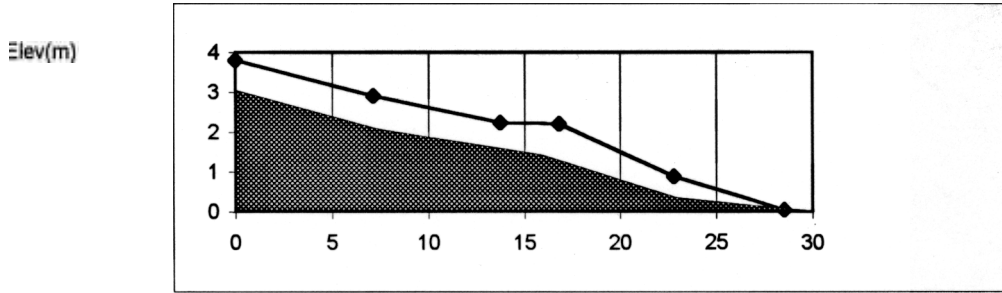

Profile 17

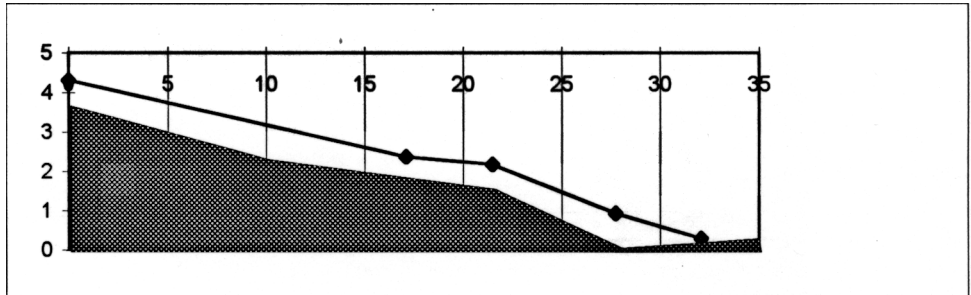

Profile 19

11.15

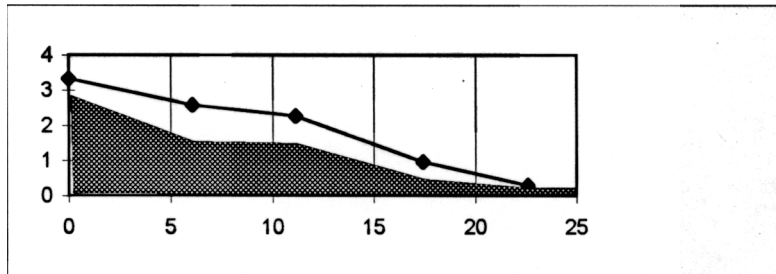

## Keys

- Rock Profile
- Beach Profile

# GOOD SAMARITAN BEACH

Profile 2

DIST	ELEV
0.00	4.78
9.54	4.00
17.79	3.17
24.04	2.73

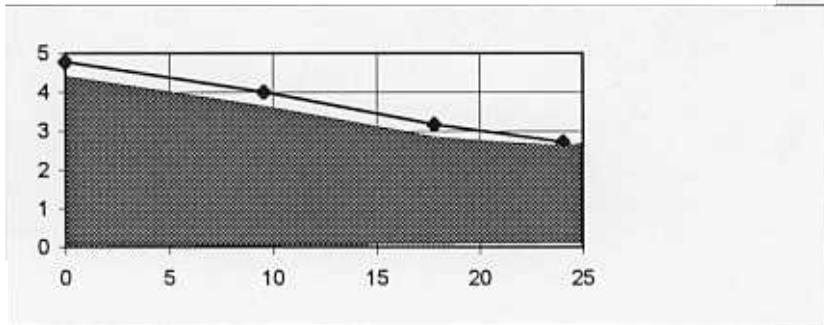

Profile 4

0.00	4.73
15.42	3.18
21.54	2.40
31.72	1.22

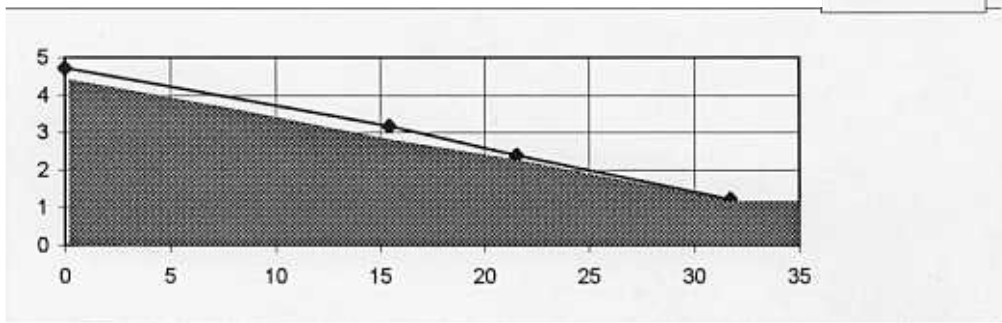

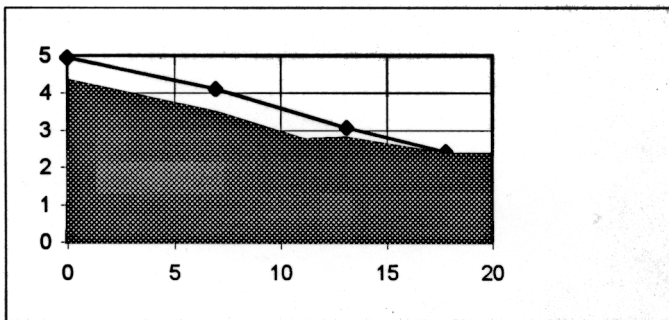

profile 5

0.00	4.94
6.95	4.11
13.12	3.06
17.78	2.42



Keys:

	Rock Profile
	Beach Profile



# GOOD SAMARITAN BEACH

Profile 6

0.00 4.92  
 7.96 3.98  
 14.96 2.93  
 20.13 2.39

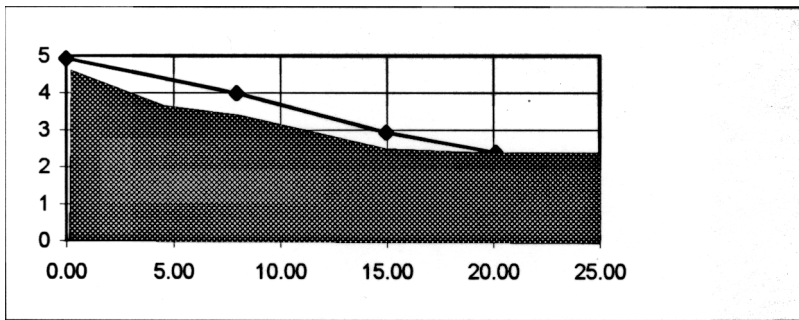

Profile 7

0.00 4.41  
 7.58 4.07  
 16.00 2.77  
 28.94 1.42

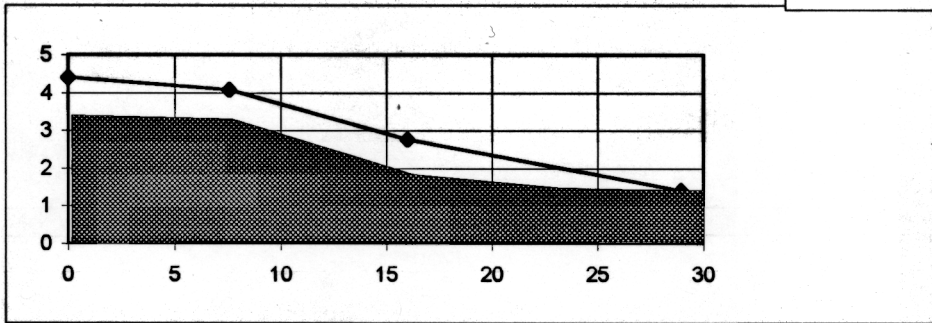

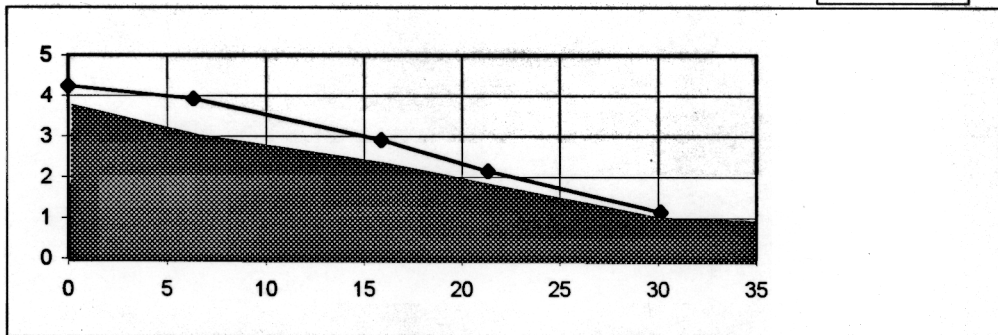

Profile 8

0.00 4.24  
 6.32 3.91  
 15.88 2.90  
 21.32 2.14  
 30.14 1.14



Keys:

 Rock Profile  
 Beach Profile

## APPENDIX H

### Proposal to Cabinet for an Integrated Coastal Management for Tonga

#### BACKGROUND

1. The National Environmental Management Strategy (NEMS) for Tonga, which was prepared in 1993 jointly by the Ministry of Lands, Survey and Natural Resources and the South Pacific Regional Environment Programme (SPREP), details under Strategy 9 the following goals:

- (i) Systematically develop and implement coastal area management plans; and
- (ii) Increase awareness by decision-makers and the general community of the values of the coastal area and of inshore marine resources.

2. In June 1994, in a joint initiative by the Ministry of Fisheries and the Ministry of Lands, Survey and Natural Resources, a decision was made to begin the process necessary to achieve these goals. A joint proposal was prepared and His Majesty's Cabinet, in Cabinet Decision 1169 of the 2nd August, 1994, approved the following recommendations:

- (i) The need for a Coastal Management Plan be officially recognised;
- (ii) The South Pacific Regional Environment Programme (SPREP) be approached by the Secretary for Lands, Survey and Natural Resources to fund a Meeting to discuss the ways in which Tonga can best achieve a Coastal Area Management Plan; and
- (iii) This high level Meeting be composed of Heads of Government Ministries together with representatives of the private sector and aid agencies, and be held in Tonga under the sponsorship of SPREP and coordinated by the Ministry of Lands, Survey and Natural Resources in cooperation with the Ministry of Fisheries.

3. In response to this Cabinet Decision and further discussions between SPREP and the two Government agencies involved, it was decided that the recommendations of the Cabinet Decision could best be implemented by holding two multi-sectoral meetings. Further, the Secretary for Lands, Survey and Natural Resources extended an invitation to the Director of the South Pacific Applied Geoscience Commission (SOPAC) to participate in the meetings which he gladly accepted.

4. The first of these meetings would be a Preliminary Meeting attended by representatives of all of the Government and private sector agencies considered to have a stake in the coastal area, together with senior members of SPREP and SOPAC. This Meeting would aim to draft a policy framework and Strategic Plan for the development of Integrated Coastal Area Management in Tonga.
5. The second of these meetings would be a High Level Meeting involving heads of government Ministries and senior representatives of the private sector, aid agencies, SPREP and SOPAC. This meeting would be given the task of reviewing the output of the Preliminary Meeting in order to ratify the Strategic Plan for Integrated Coastal Area Management in Tonga,
6. The Preliminary Meeting was held from the 6th to the 9th of December, 1994. Attending the Meeting were 39 participants representing government, private sector, aid agencies, NGO's, SPREP and SOPAC. A meeting report, including the papers presented, list of participants and agenda, is being prepared separately.
7. The High Level Meeting was held on the 13th and 14th of December, 1994. Attending the Meeting were 34 participants representing government, private sector, aid agencies, NGO's, SPREP and SOPAC. A meeting report, including the papers presented, list of participants and agenda, is being prepared separately.

#### **THE NEED FOR INTEGRATED COASTAL AREA MANAGEMENT**

8. The need for Integrated Coastal Area Management in the Kingdom of Tonga is due to the increased use of, and pressure on, the coastal area for infrastructure, commercial, residential, and recreational uses.
9. Protection of the coastal area of the Kingdom is fundamental to the sustained economic, social and cultural development of the nation.
10. It is becoming more and more difficult in Tonga to manage any one particular coastal natural resource, enhance one economic sector, or maintain cultural values in the absence of an integrated framework for policy planning and management in matters relating to coastal areas.
11. Integrated Coastal Area Management is a comprehensive, multi-sectoral, integrated approach to the planning and management of coastal areas. It encompasses a process of assessment, monitoring, planning and management for the sustainable development, multiple use and conservation of coastal areas, resources and ecosystems.

#### **ISSUES**

12. The Preliminary Meeting considered that the following issues should be examined in the development of any Integrated Coastal Area Management Programme for Tonga.
  - (i) An operational description of the “coastal area”.
  - (ii) Adequate and effective community involvement in the management of coastal areas.

- (ii) Adequate and effective community involvement in the management of coastal areas.
- (iii) The decline in coastal fisheries resources and the use of destructive fishing practices.
- (iv) Potential conflicts in the use of coastal marine areas.
- (v) Potential conflicts in the use of coastal land areas, including land reclamation.
- (vi) Impacts of projected climate change and sea level rise on coastal areas.
- (vii) The effects of sand mining in coastal areas.
- (viii) Natural hazards [earthquakes, volcanic eruptions, storm surges, cyclones, erosion, etc) impacting on coastal areas.
- (ix) Appropriate protection of assets.
- (x) Pollution (sewerage, urban run-off, agricultural, oil spill, dumping, waste disposal, etc).
- (xi) Degradation and destruction of mangrove areas.
- (xii) Limited public education and awareness of issues impacting on coastal areas.
- (xiii) Training Programme for personnel responsible for implementing the ICAM programme.
- (xiv) Adequacy and effectiveness of regulatory regimes pertaining to coastal areas.
- (xv) Lack of relevant information necessary for effective management.

### **POLICY STATEMENT**

13. Environmental problems in coastal areas of the Kingdom of Tonga are becoming more prevalent. The coastal areas are vital to the social, cultural and economic well being of the Tongan people, as well as the sustainable development of the Kingdom. With the inter-connected nature of small island ecosystems, activities on land will severely affect the quality of coastal waters.

14. There is currently an urgent need in Tonga for action to address a range of coastal issues, including, but not limited to, coastal habitat degradation and destruction, pollution from sewerage and urban runoff, destructive fishing practices, and beach sand removal. To address these issues there is a need for coordination and cooperation amongst the various government and non-government sectors.

15. Integrated Coastal Area Management (ICAM) has been identified as the most appropriate mechanism to address coastal issues, and ensure the Kingdom of Tonga is on the path towards sustainable development.

### **AIM**

16. The overall aim of an Integrated Coastal Area Management Programme for Tonga is to provide for the best long-term and sustainable use of the coastal natural resources and for the perpetual maintenance of the most beneficial natural environment for the enjoyment of future generations.

## GOALS

17. *Maintain a high quality coastal environment:* The coast is a major national resource, providing food, livelihoods, and protection. These values will not last forever without effective management. ICAM would provide the means for maintaining the quality of the coastal environment.
18. *Protect valuable species:* Many coastal species require special protection. ICAM would provide measures for their conservation.
19. *Conserve critical coastal habitats and processes:* Habitats and processes of special importance to the functioning of coastal ecosystems - forests, mangroves, coral reefs, beaches and lagoons - would be protected through an ICAM programme.
20. *Control pollution:* Pollution from point sources and from land runoff as well as accidental spills of pollutants (such as oil) foul coastal waters. The human health problems and ecological disruption caused by such pollution would be addressed by an ICAM programme.
21. *Provide development guidance:* Much of the degradation of coastal areas is from inadvertent side effects of development in and near coastal areas. An ICAM programme would facilitate developers to reduce impacts, especially through the application of Environmental Impact Assessment (EIA). The integration of sectoral programmes will assist Tonga in its goal to achieve sustainable development.
22. *Provide planning guidance:* To avoid development initiatives which would be damaging to coastal areas, advice would be provided to developers and planners through ICAM and EM. It also provides the mechanism through which coordination and cooperation among the various sectors can occur.
23. *Provide legislative framework:* ICAM provides a legislative framework for the effective management of coastal areas.
24. *Identify critical lands:* Certain areas of the coast have special potential for various activities - nature protection, economic development, and so forth. Other coastal lands are susceptible to natural hazards. The ICAM programme would assist in identifying such lands.
25. *Restore damaged ecosystems:* Many otherwise productive coastal habitats have been damaged but are restorable. The ICAM programme would offer opportunities to identify and restore such habitats.
26. *Public awareness:* ICAM can play an important role in creating public awareness of coastal values and needs for conservation and management.
27. *Identify and develop alternative sources of sand and gravel:* An ICAM programme can facilitate the identification and development of alternative sources of sand and gravel to reduce the degradation of beaches.
28. *Involve all coastal stakeholders in the planning and management process:* An effective ICAM programme would ensure the participation of all the coastal stakeholders.

29. *Maintain social and cultural integrity:* The maintenance of healthy coastal areas is important for the well being of the Tongan people. The protection of historical and archaeological sites can be facilitated through the ICAM programme.

## STRATEGIC PLAN

30. The meetings considered the requirements of a short- to medium-term strategy for preparing an ICAM programme for the Kingdom of Tonga. This two stage strategy covers the activities necessary to follow on from the High Level Meeting and the initiation of an ICAM process.

### Stage 1

31. *Preparation of a Cabinet paper at the conclusion of the Preliminary and High Level Meetings:* The first step in the strategic planning process was the holding of the Preliminary and High Level Meetings and subsequent reporting to Cabinet. This initial step has now been completed with the submission of this report to Cabinet. A small secretariat was established to formalise this submission to Cabinet seeking authority for the establishment of a process of ICAM.

32. The secretariat consists of two senior staff from the Ministry of Lands, Survey and Natural Resources; two senior staff from the Ministry of Fisheries; and one senior staff person from the Central Planning Department.

33. *Interim measures:* It is proposed that a number of key tasks be undertaken to prepare the way for a full ICAM programme, which would also serve to demonstrate the commitment of the Government of Tonga to ICAM.

34. These initial key tasks are to:

- (i) Initiate a review of legislation pertaining to coastal management in order to identify gaps, duplications and inefficiencies;
- (ii) Consider and make recommendations to Cabinet on an operational description of the coastal area in conjunction with options for the necessary ICAM regulatory regime;
- (iii) Inform Cabinet on funding mechanisms, both immediate (for project proposal for aid funding), and long-term (considering the sustainability of an ICAM programme in terms of the commitment of resources by the Government of Tonga);
- (iv) Inform Cabinet on the scope and nature of an appropriate ICAM regime for Tonga;
- (v) Inform Cabinet on long-term mechanism(s) for integration of sectors and planning, including assessment of existing similar purpose structures such as Development Coordination Committee and Inter-Departmental Environment Committee;

- (vi) Inform Cabinet on desirable institutional arrangements including institutional structures, responsibilities and mandates, and particularly the identification of a lead agency;
- (vii) Inform Cabinet on the nature and scope of community involvement in the ICAM process.

35. In order to properly carry out these initial key tasks, it is proposed that an Interim Integrated Coastal Area Management Coordinating Committee be established and meet once a month until such time as a full ICAM programme is agreed to, funded and implemented.

36. This Interim Committee should consist of senior representation from the following Ministries and other organisations, with the Ministry of Lands, Survey and Natural Resources nominated as the interim lead agency. The Chairmanship of the Interim Committee should be on an annual rotating basis and at the Ministerial level.

- . Ministry of Lands, Surveys and Natural Resources
- . Ministry of Fisheries
- . Central Planning Department
- . Ministry of Foreign Affairs
- . Ministry of Finance
- . Ministry of Health
- . Ministry of Works
- . Ministry of Labour, Commerce and Industries
- . Ministry of Education
- . Ministry of Agriculture and Forestry
- . Ministry of Marine and Ports
- . Ministry of Police and Prisons
- . Crown Law Department
- . Tonga Visitors Bureau
- . Tonga Defence Services
- . Non-Government Organisations
- . Invited members, including non-government representation.

37. *Preparation of an ICAM proposal for donor support:* It is noted that there is already some bilateral interest in funding such a project. It is therefore proposed that the Interim ICAM Coordinating Committee, delegating to the secretariat, work to prepare project documentation for the Central Planning Department and Cabinet outlining a formal Government of Tonga proposal for funding a full ICAM programme.

## **Stage II**

38. *Implementation of an ICAM programme for Tonga-* This stage can be initiated when the Stage I tasks have been completed. It is proposed that the interim measures identified above be carried out within 12 months.

## **Timetable for Strategic Planning Period (Stage I)**

39. A recommended timetable for the Strategic Planning Period (Stage I) is as follows:

- (i) Secretariat recommended by High Level Meeting (by 16 December 1994)
- (ii) Cabinet paper prepared for Cabinet before the end of December 1994, by the Director of Central Planning, the Secretary of Fisheries and the Secretary of Lands, Survey and Natural Resources.
- (iii) Aid funded ICAM proposal prepared by the secretariat for the February meeting of the Interim ICAM Coordinating Committee.
- (iv) Interim ICAM Coordinating Committee established for first meeting in February 1995 to consider the proposal prepared by the secretariat and to elicit comments on the proposal from other interested parties.
- (v) Funding proposal for donor support for ICAM programme finalised by Interim ICAM Coordinating Committee, and detailed work programme for interim tasks established (March meeting)
- (vi) March 1995-February 1996 - Interim ICAM Coordinating Committee progressively works at interim tasks.



## RECOMMENDATIONS TO HIS MAJESTY'S CABINET

40. It is respectfully recommended that His Majesty's Cabinet:
- (i) **Consider**, modify if necessary and endorse the establishment of an Integrated Coastal Area Management Programme for Tonga.
  - (ii) **Consider**, modify if necessary and endorse the strategic plan outlined in this report, noting the fact that this plan requires the establishment of an Interim Coordinating Committee with Ministerial level Chairmanship rotated annually, and with a small secretariat.
  - (iii) **Confirm** the Ministry of Lands, Survey and Natural Resources as the interim lead ICAM agency.
  - (iv) **Confirm** the Hon. Minister of Lands, Survey and Natural Resources as the initial Chairman of the Interim ICAM Coordinating Committee.
  - (v) **Direct** the SPREP Focal Point and SOPAC National Representative for Tonga to seek continued assistance as appropriate from these regional organisations.